

Retro Rocket Ship 49

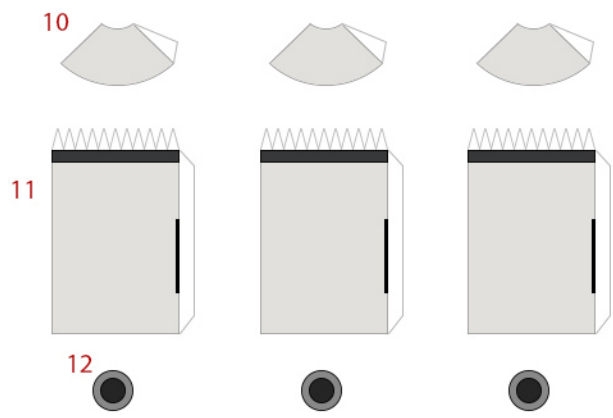

Instructions

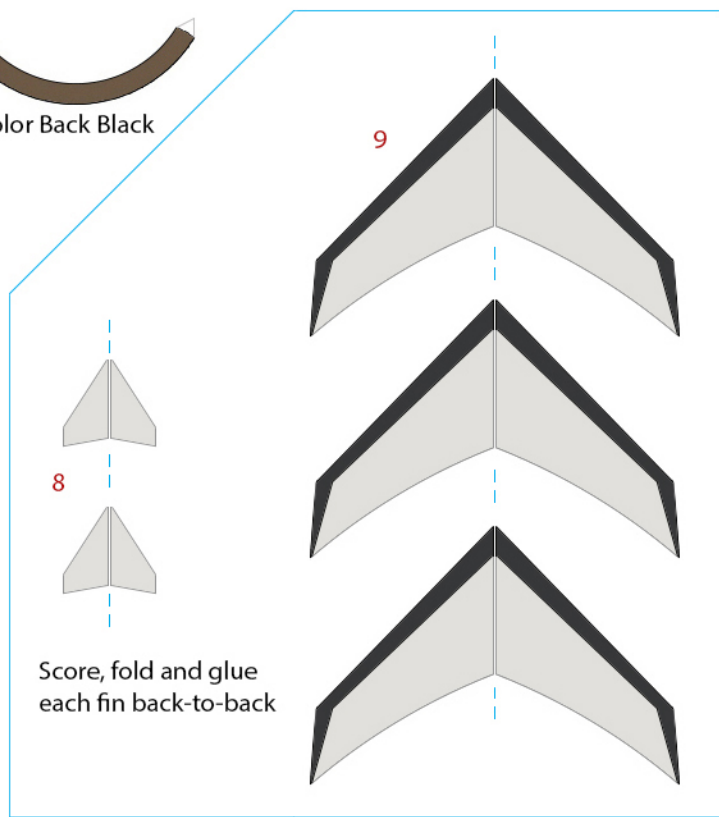
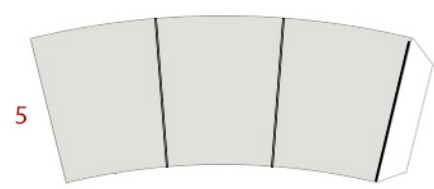
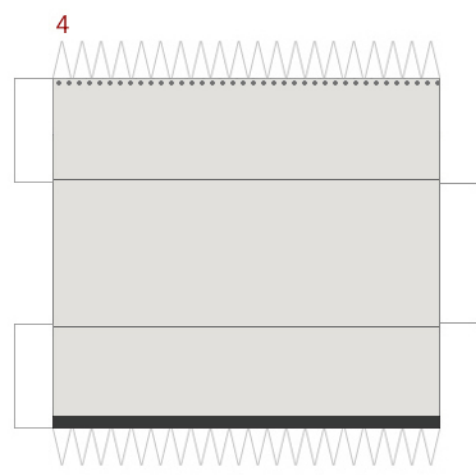
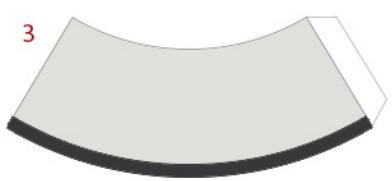
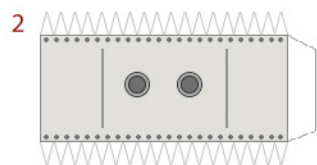
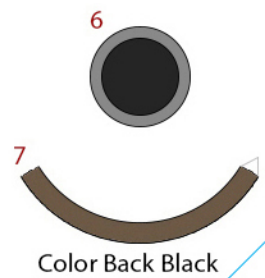
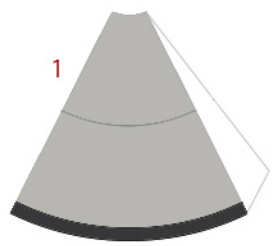
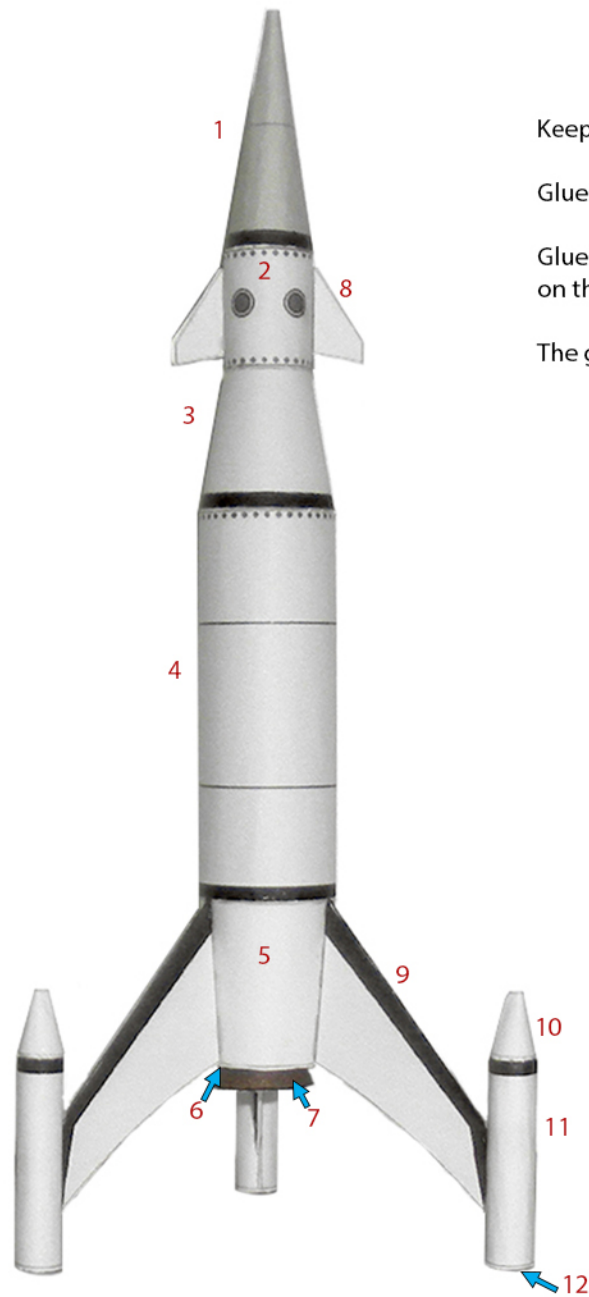

Keep all seems together

Glue 8 on the two black lines on 2

Glue the fins (Parts 9) onto the black lines on the seem on the boosters (Parts 10 -12)

The glue onto the black lines on 5.

Retro Rocket Ship 50

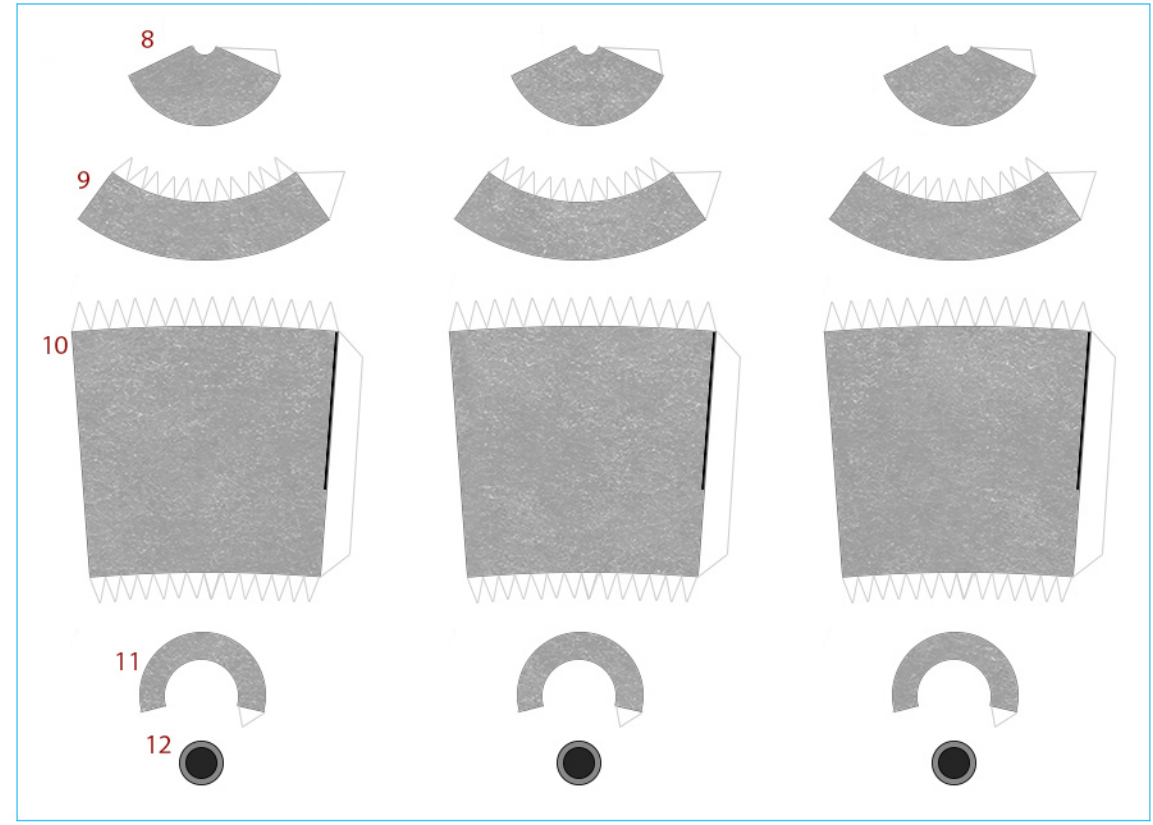
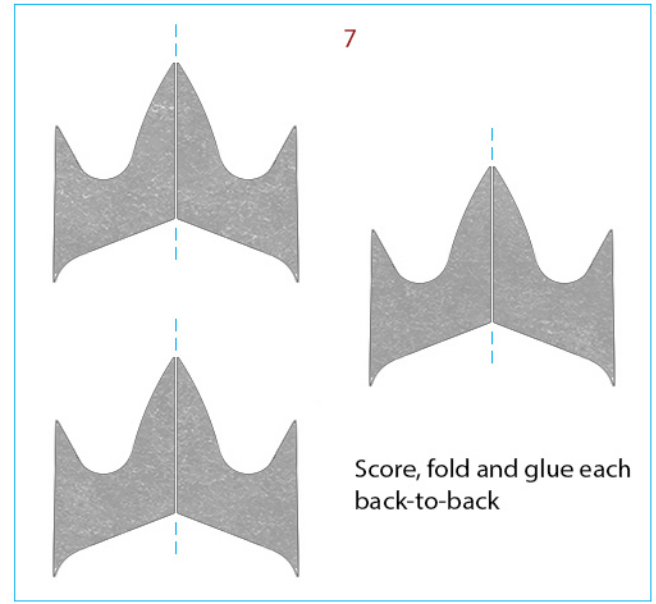
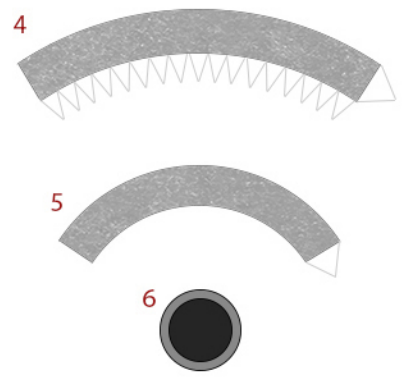
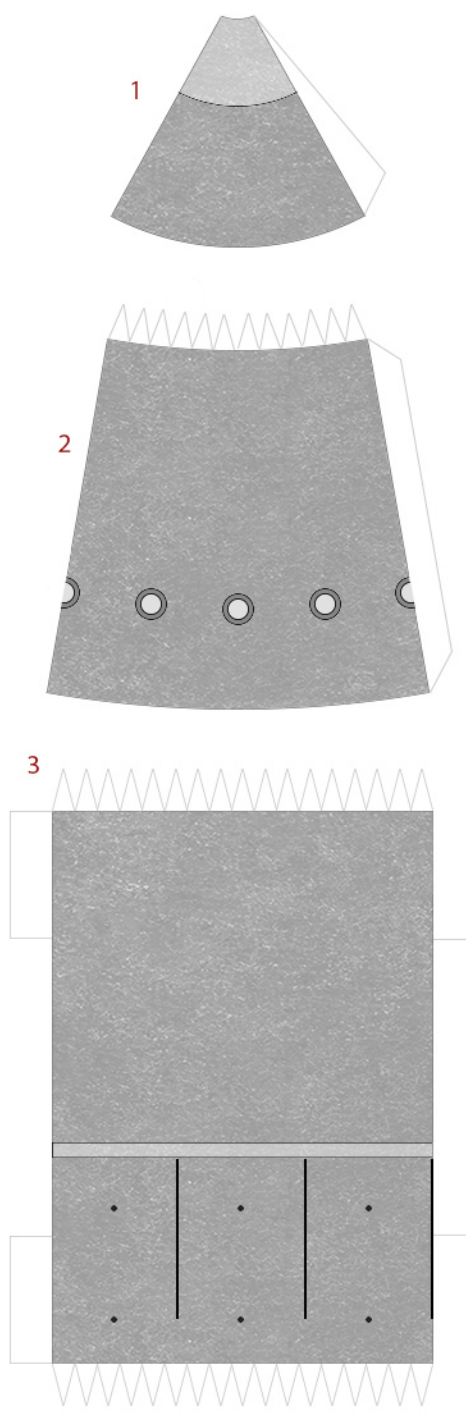

Instructions



Keep all seems together

Glue the fins (Parts 7) onto the black line at the seem of each booster

Then glue onto the black line near the bottom of Part 3

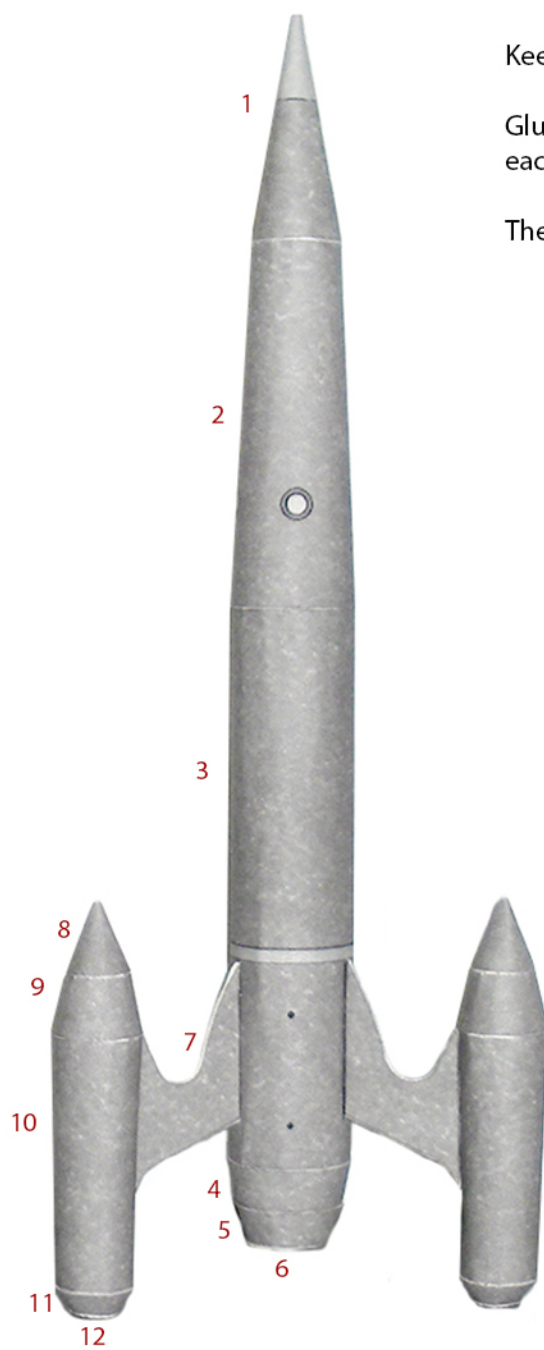

Retro Rocket Ship 51

Grey

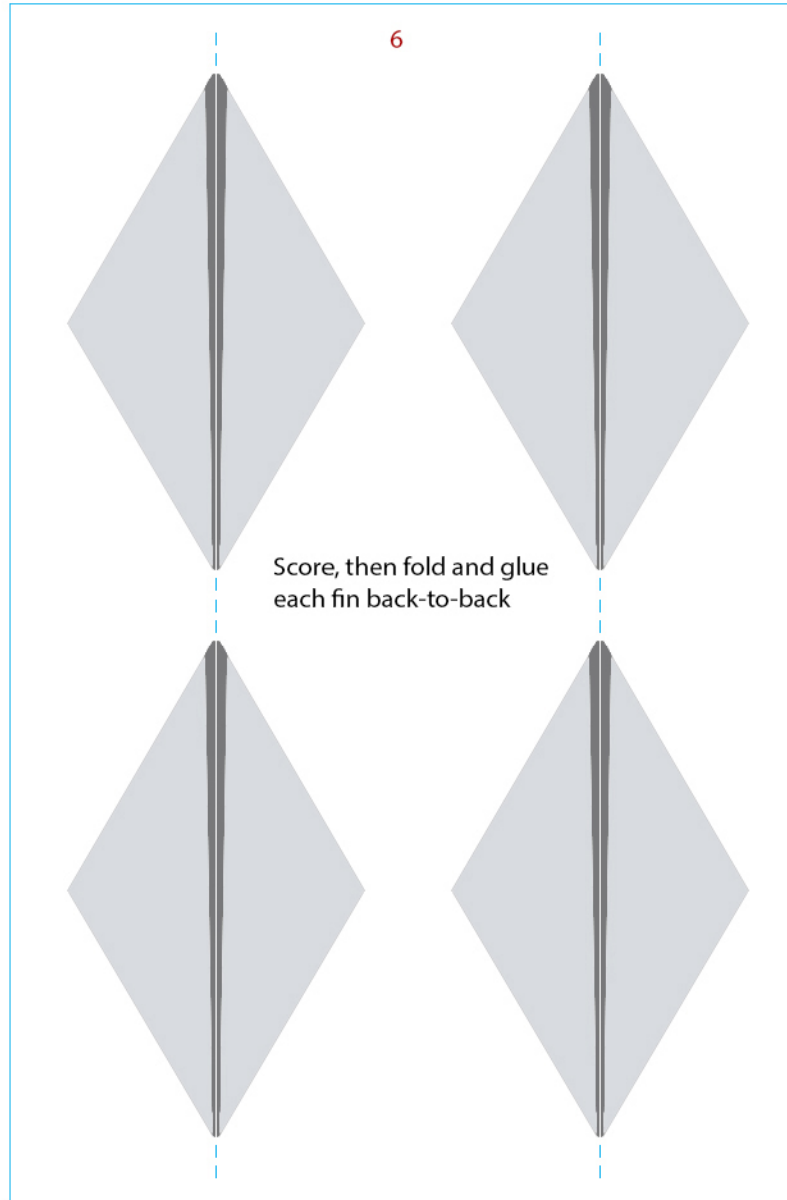
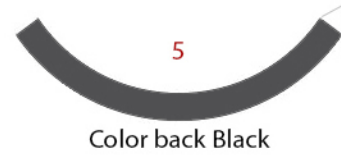
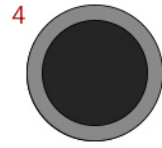
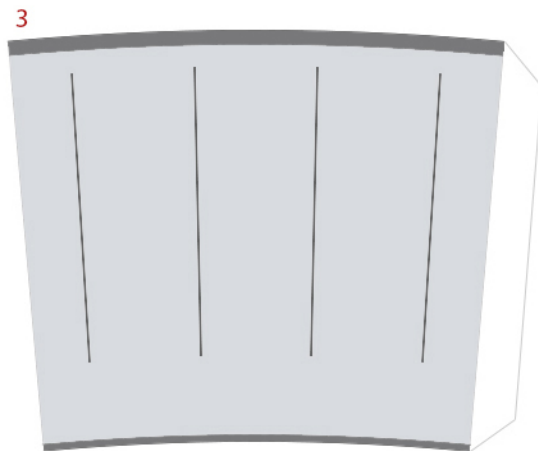
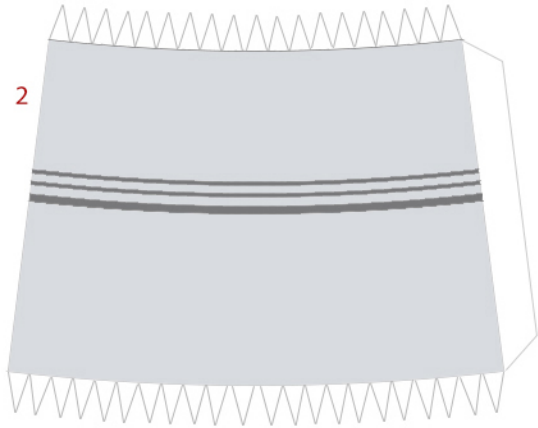
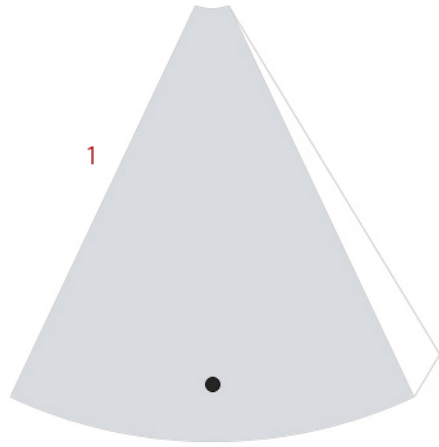

Retro Rocket Ship 51

White

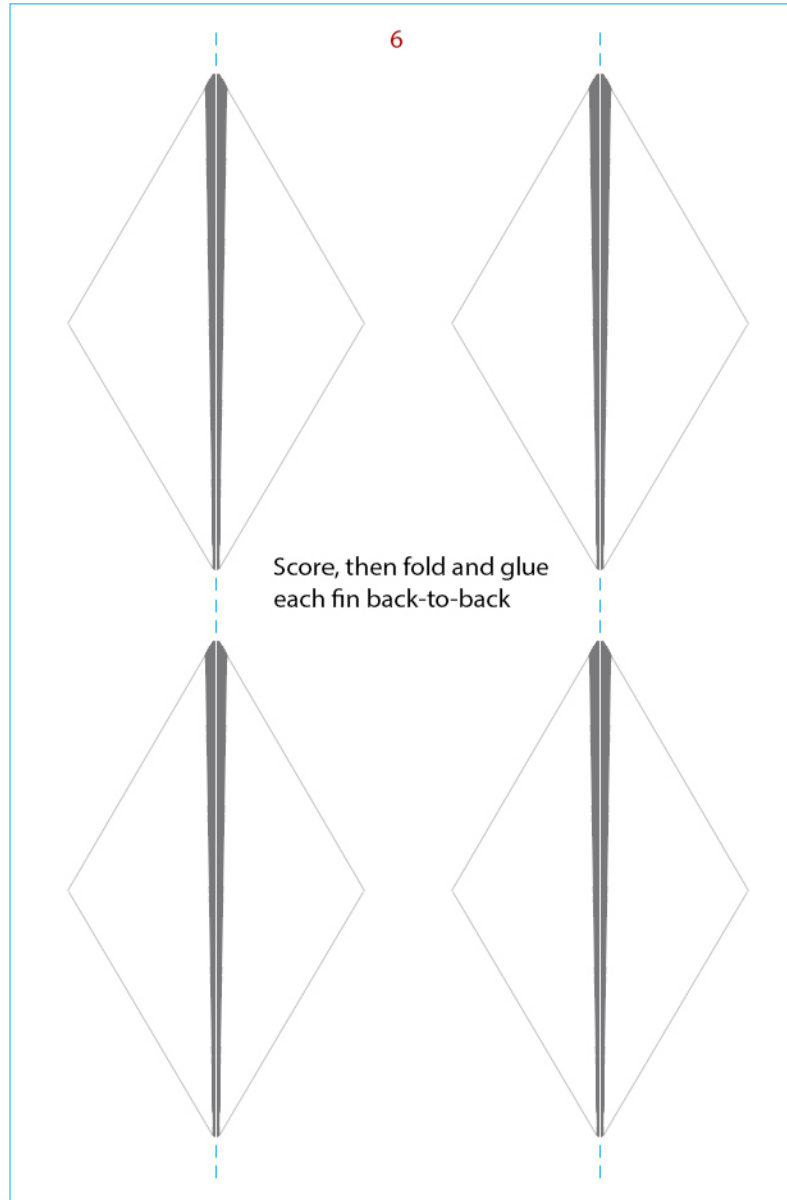
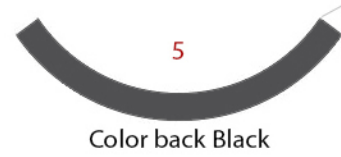
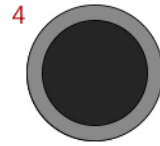
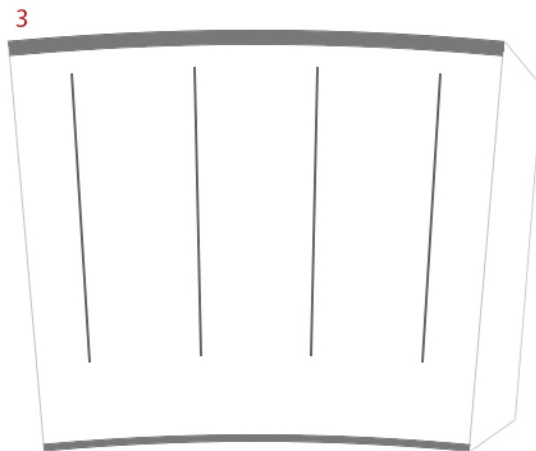
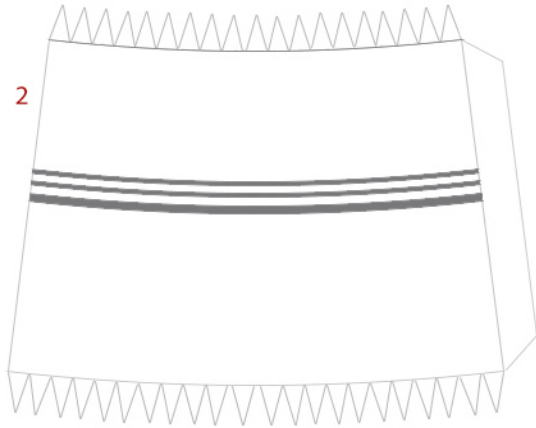
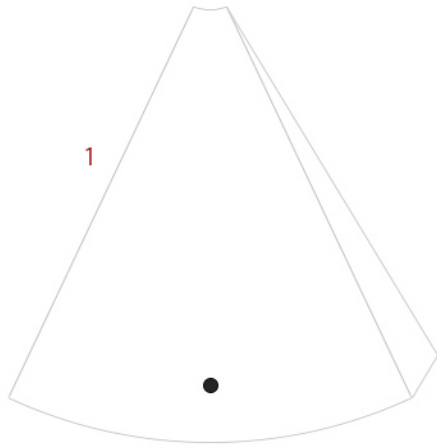

Instructions

Keep all seems together

Fins are glued on the four (4) black lines on Part 3



Retro Rocket Ship 52

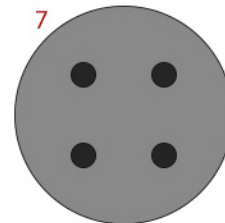
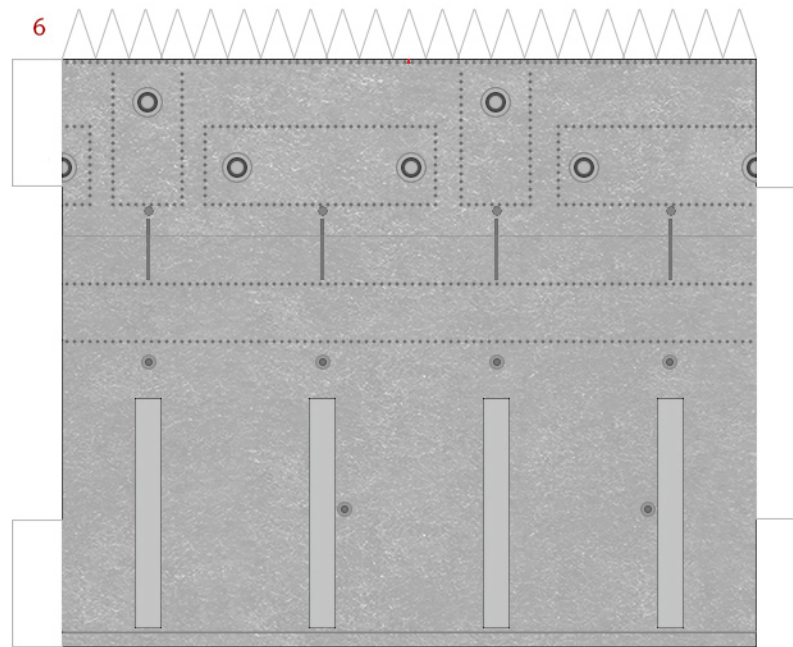
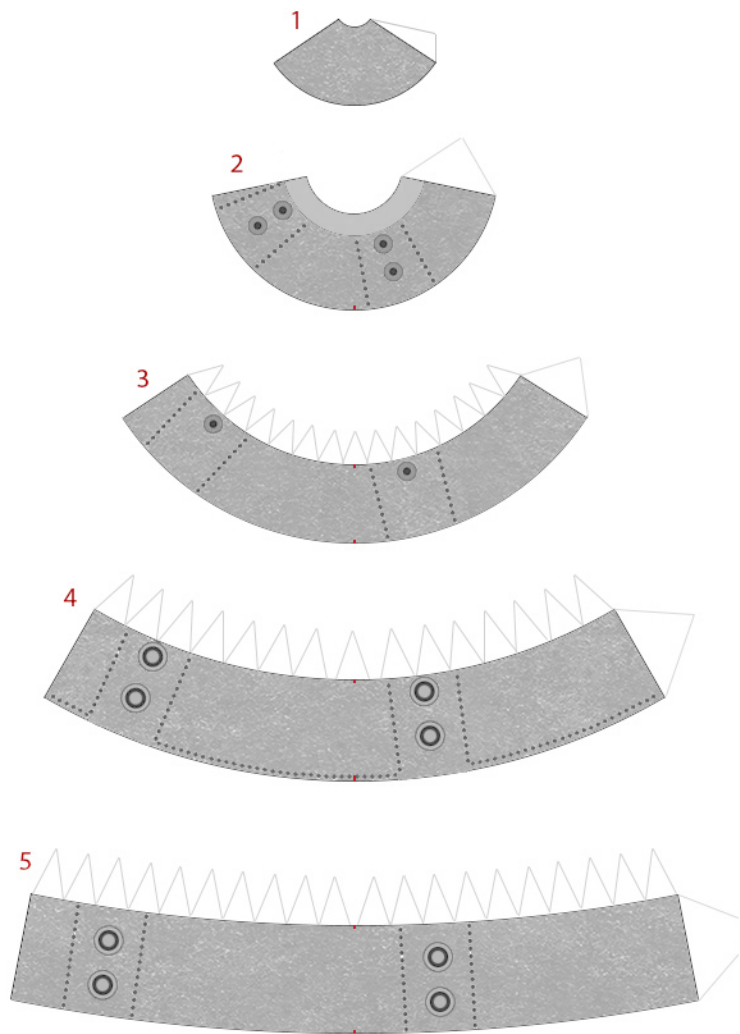

Glue to Cardstock - fits inside bottom of Part 6 above

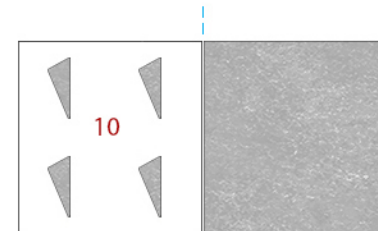

Fold and glue back-to-back

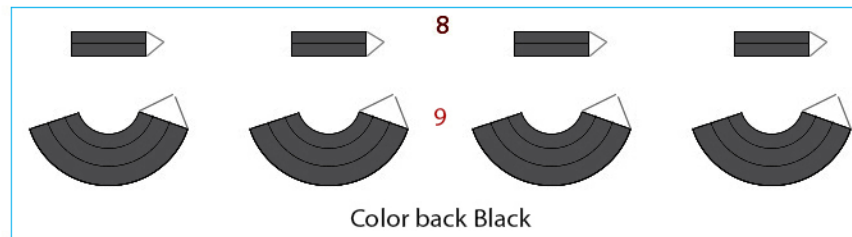

Fins

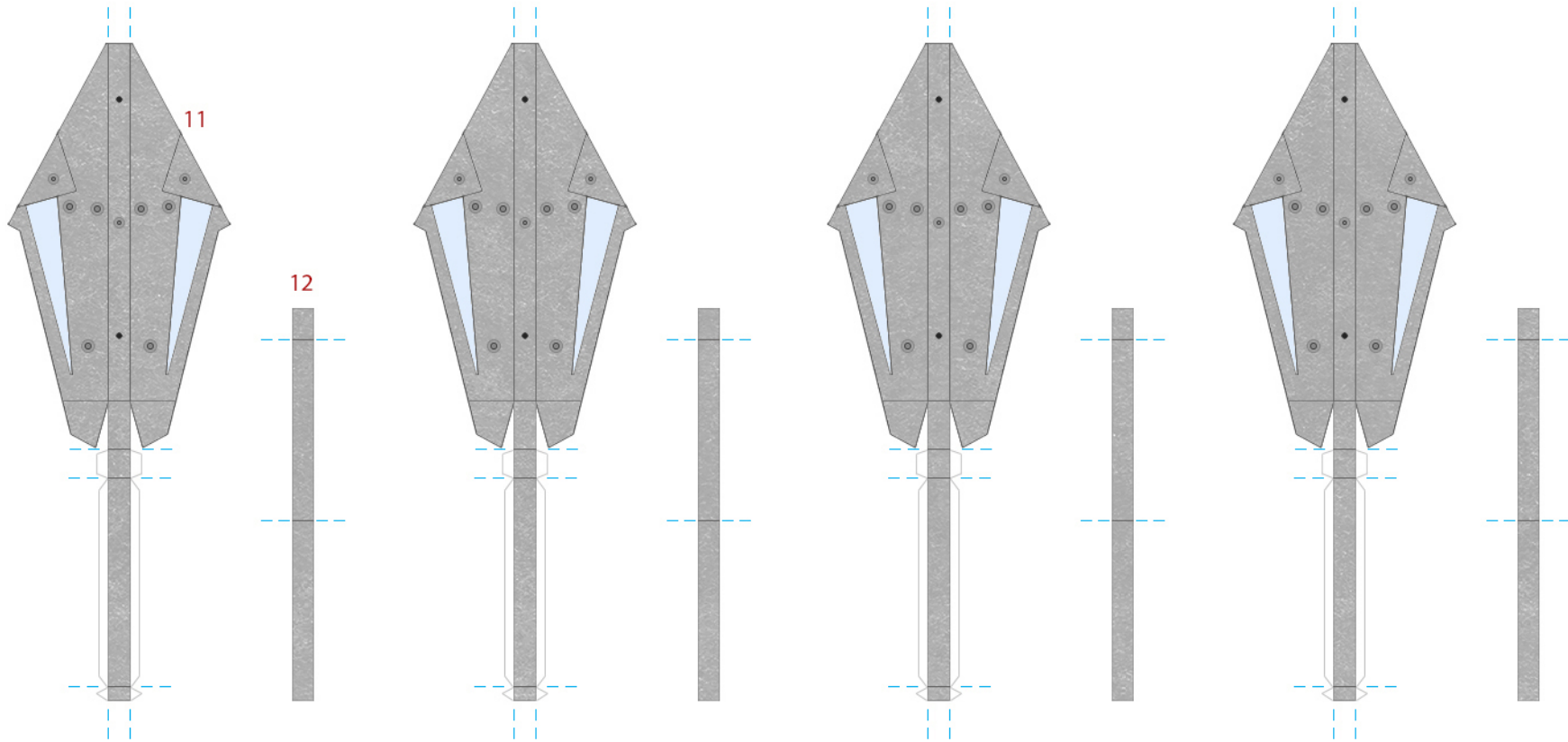

Do a good score on the blue lines (for a better, sharper fold), cut out the Blue areas from Parts 11

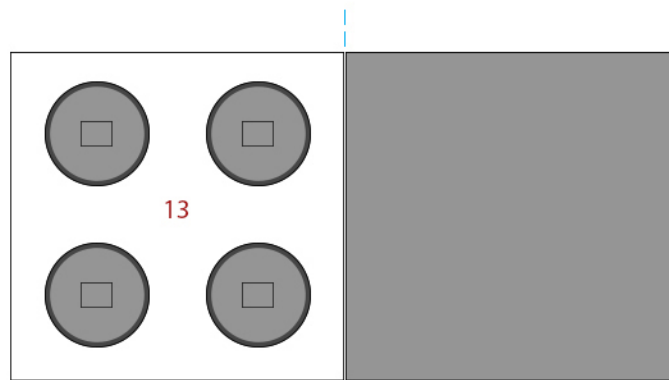

Fold, glue back-to-back

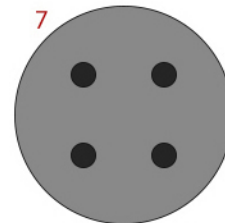
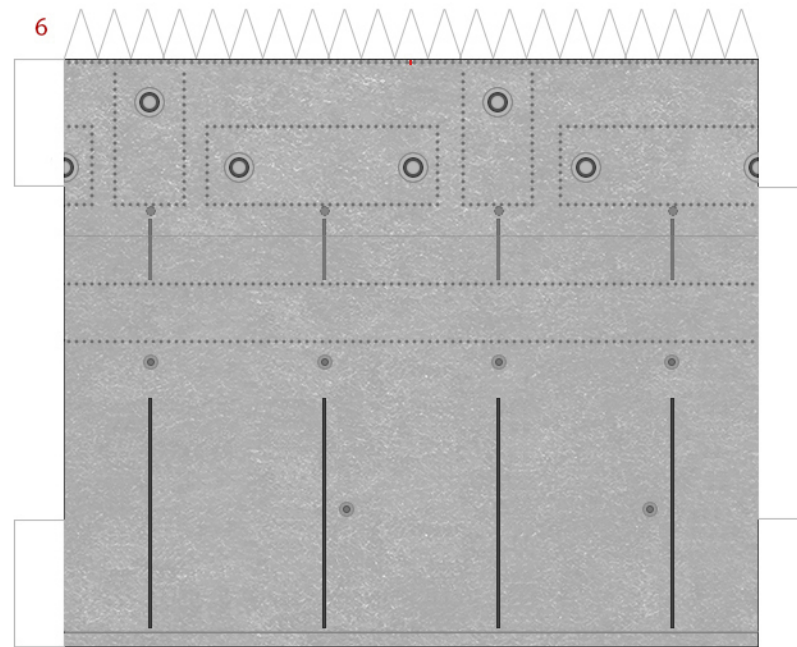
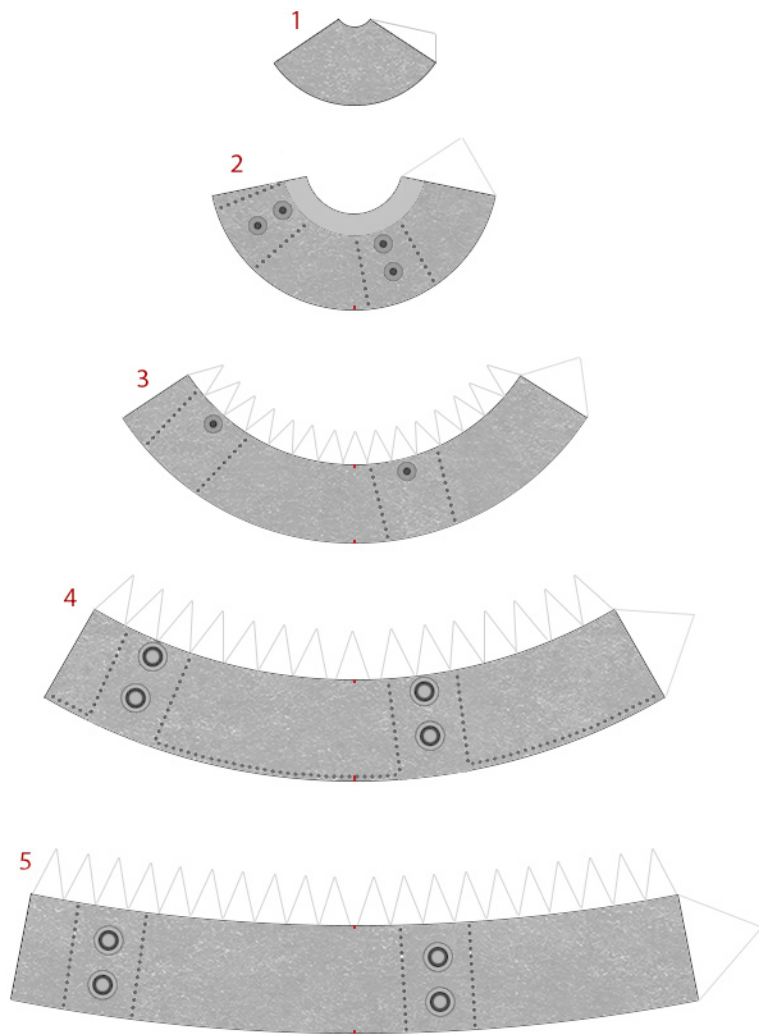

Glue to Cardstock - fits inside bottom of Part 6 above

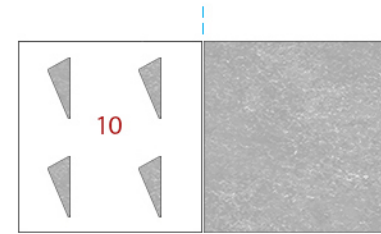

Fold and glue back-to-back

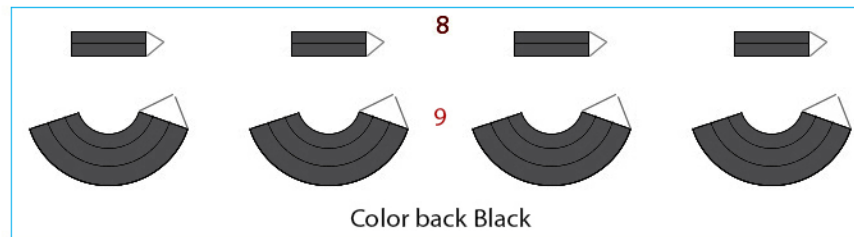

11

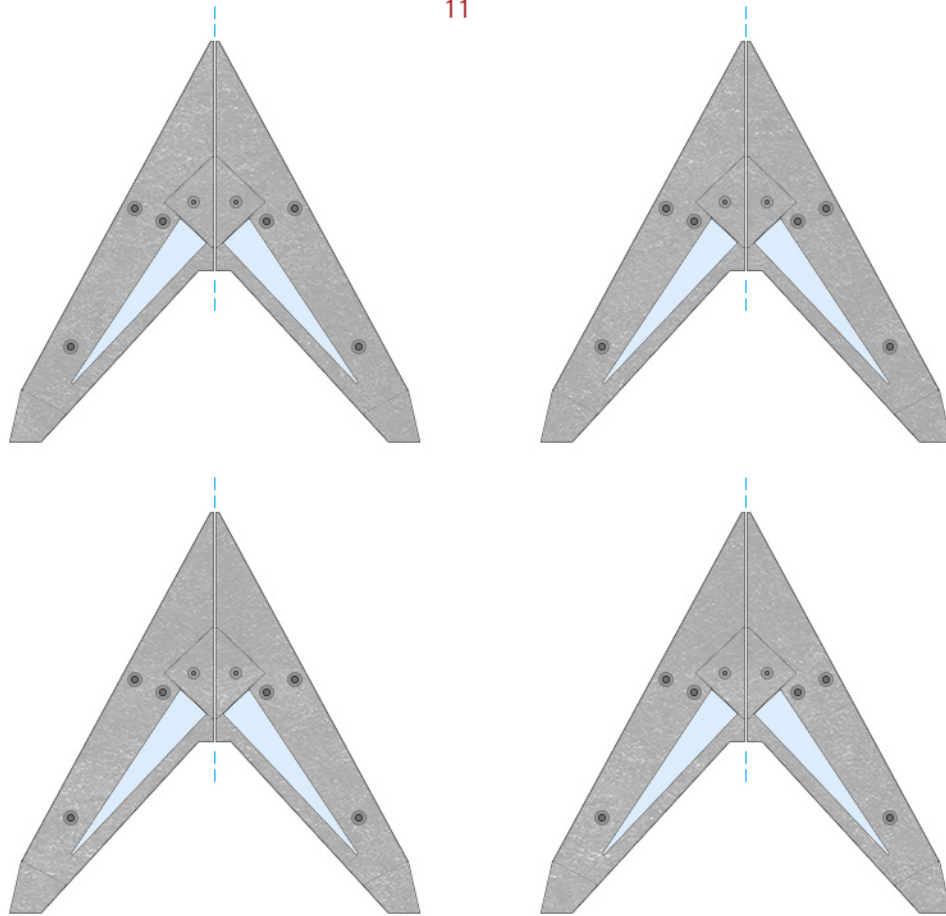

Cut out the Blue areas, score and fold back-to-back at the Blue lines

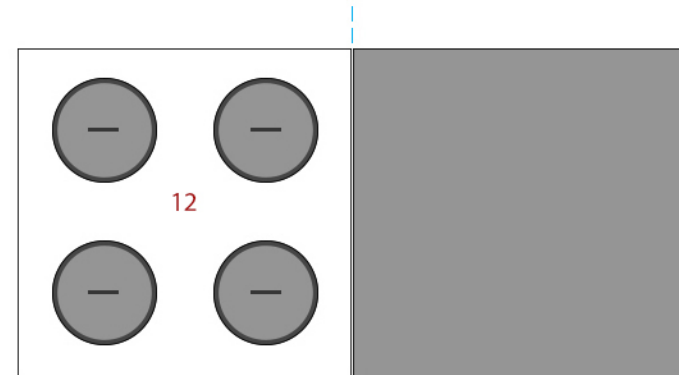

Fold, glue back-to-back

Retro Rocket Ship 52



Instructions Detailed and Easy version

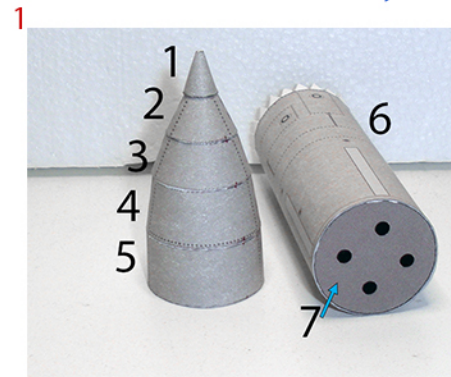

Slide Part 7 inside bottom of Part 6 and glue in place

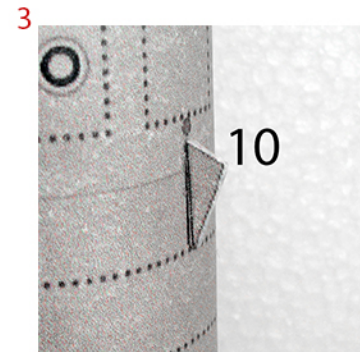
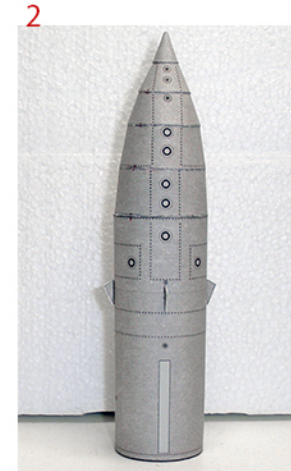

Glue on the four (4) short dark lines on Part 6

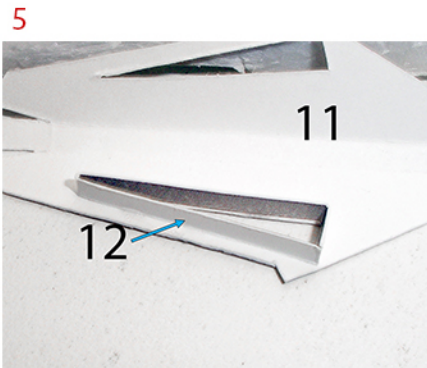

Carefully cut out the fins, cut out the Blue areas. Fold-glue 12 to a triangle with color INSIDE and glue onto the cutouts as shown.

Easy Version - cut out the Blue areas and fold-glue fins back-to-back

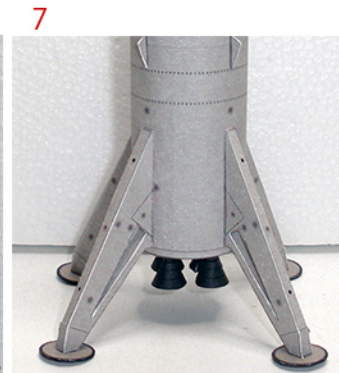
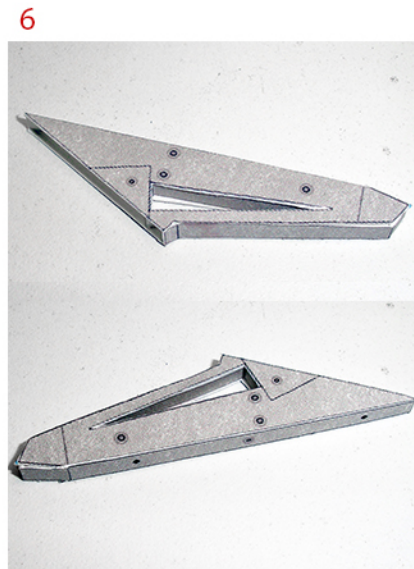

Glue onto the grey rectangles on Part 6.

Easy Version - glue on the long black lines on Part 6



Glue onto the bottom of each fin as shown

Your model is done

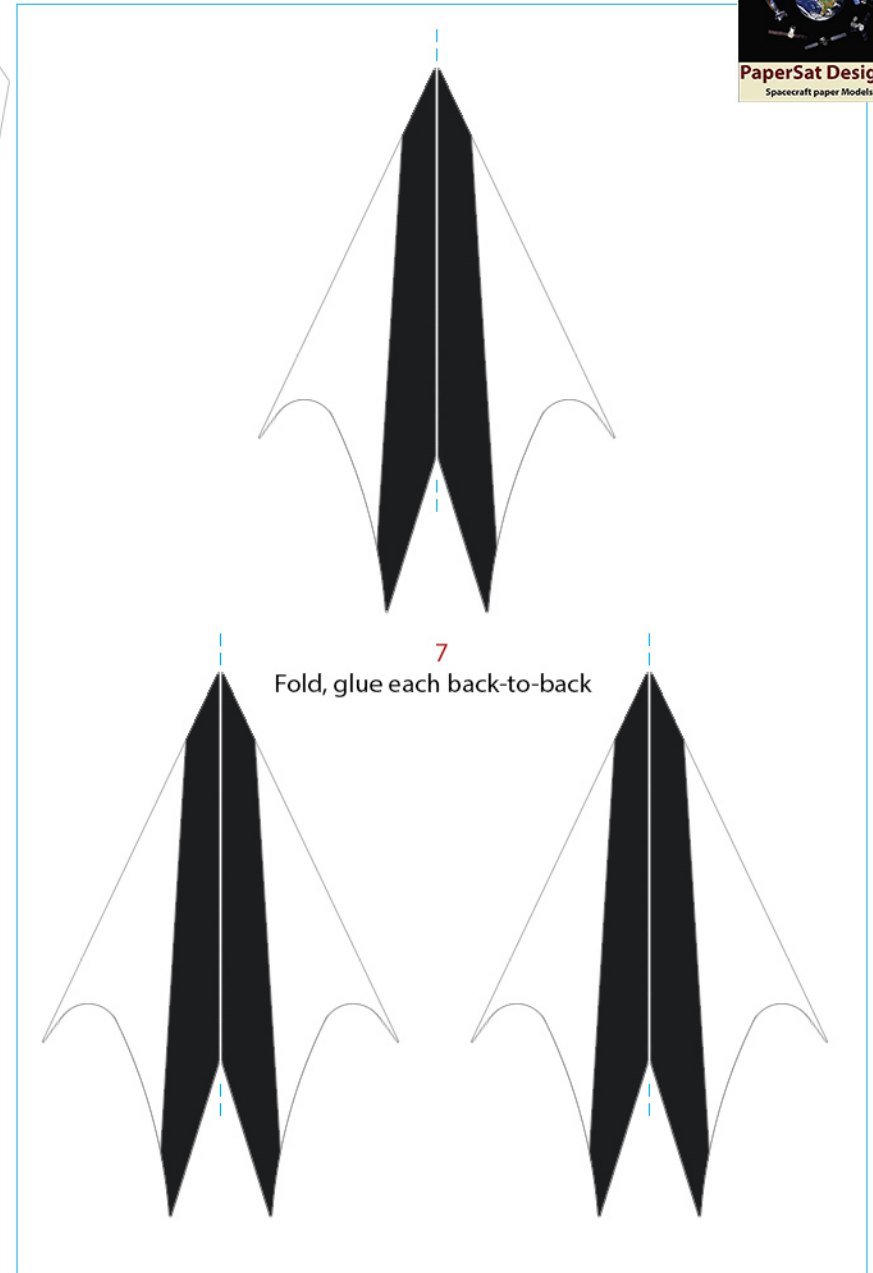
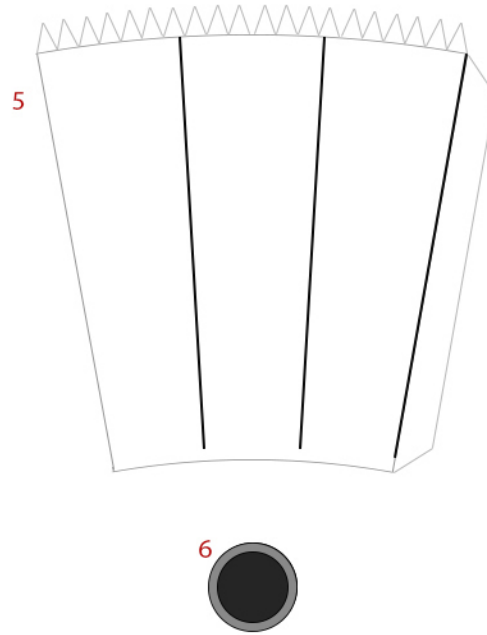
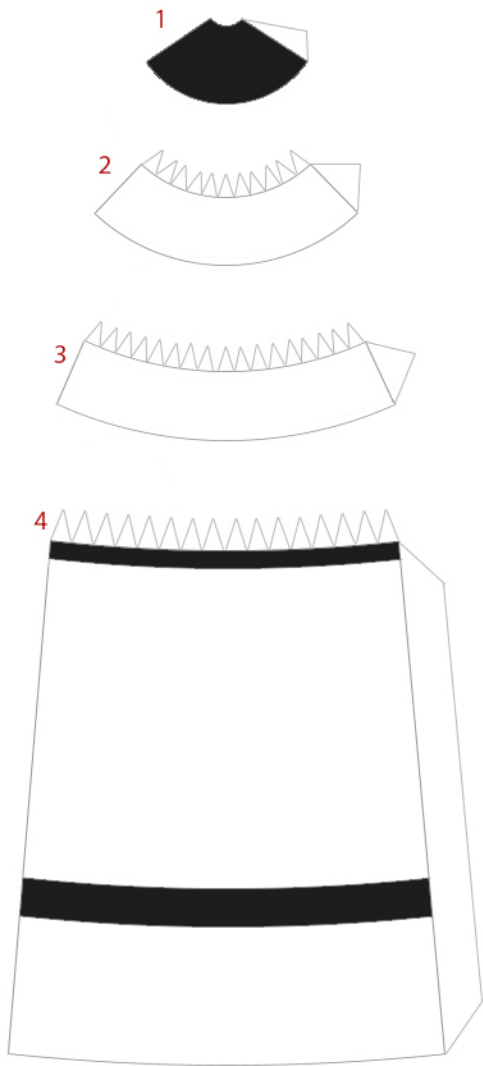

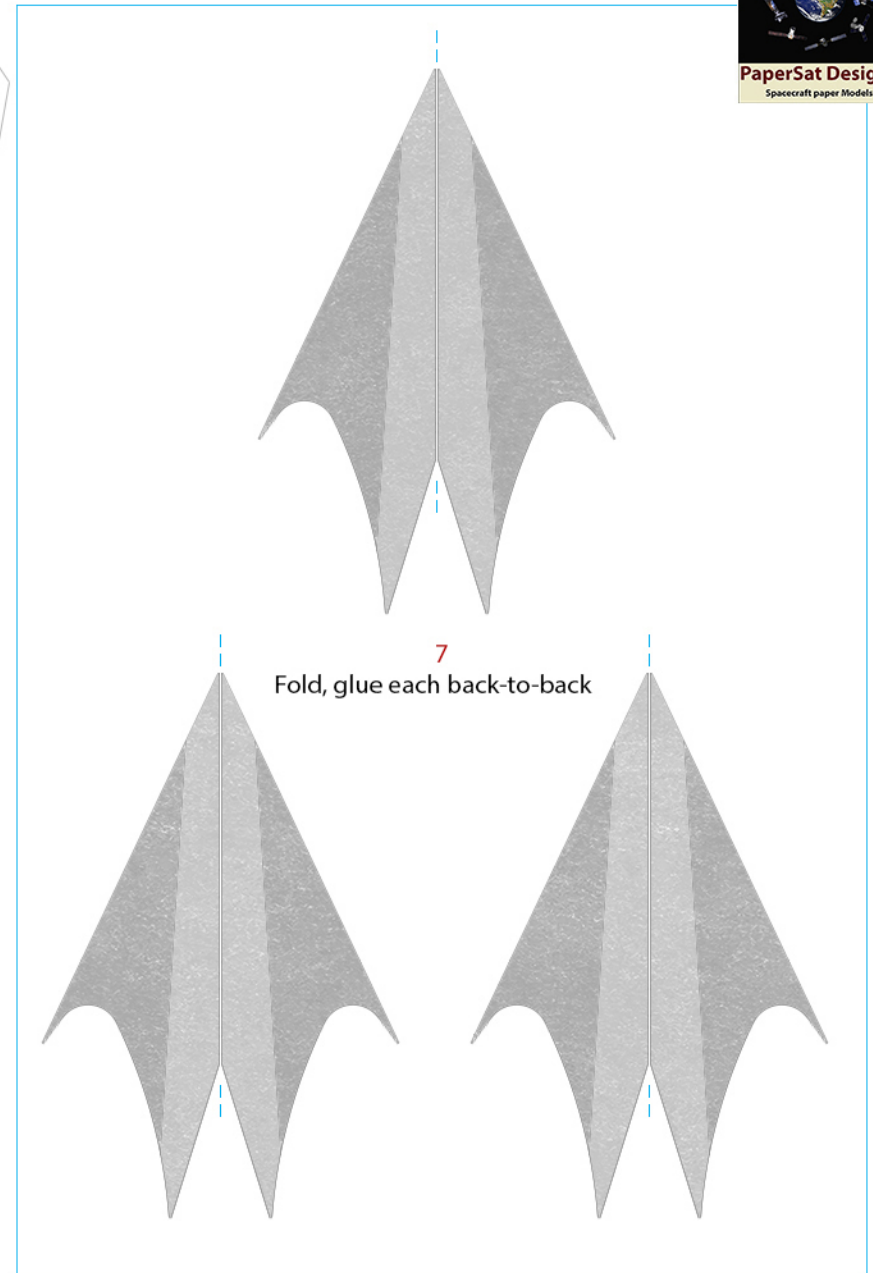
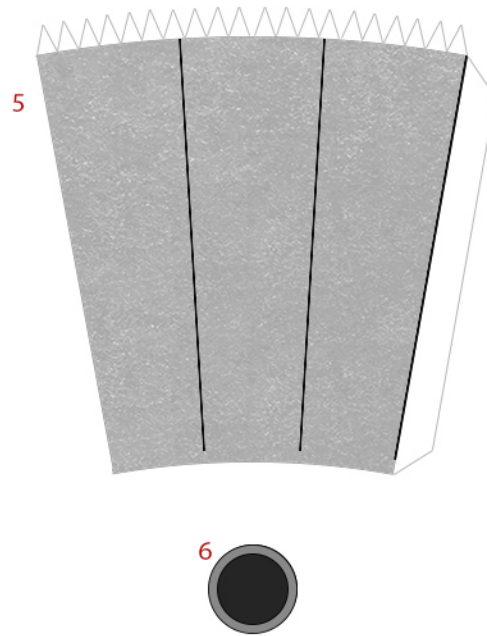
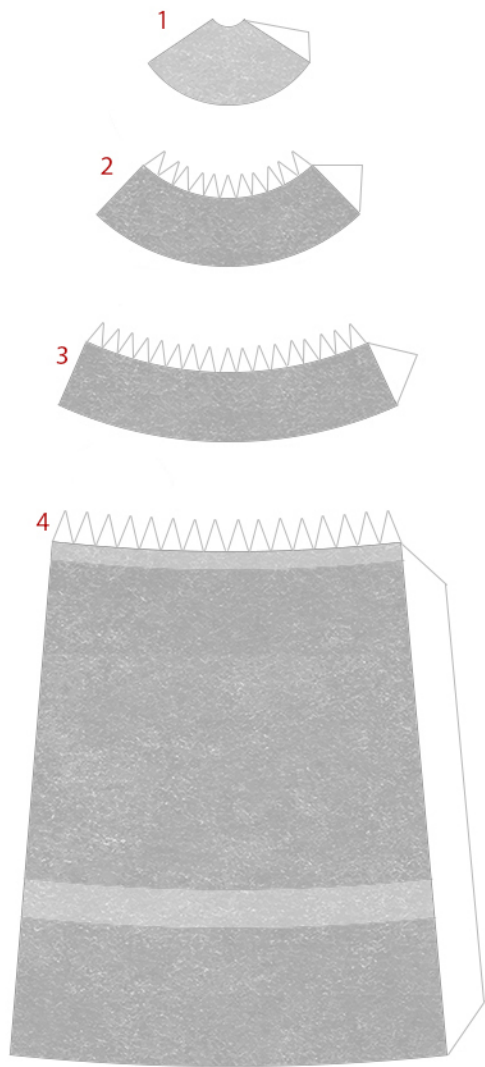

Instructions for both versions



Keep all seems together

6 is glued to bottom of Part 5

Score, fold and glue the fins (Parts 7) back-to-back and glue onto the three (3) black lines on Part 5

Retro Rocket Ship 54 Intergalactic Star Cruiser

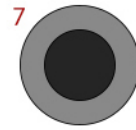
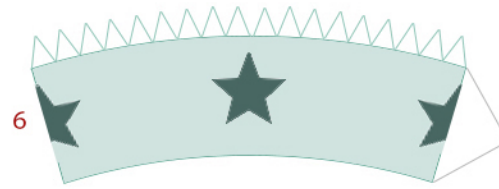
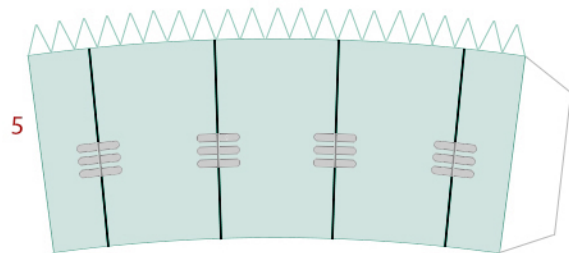
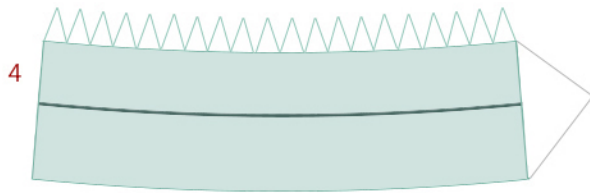
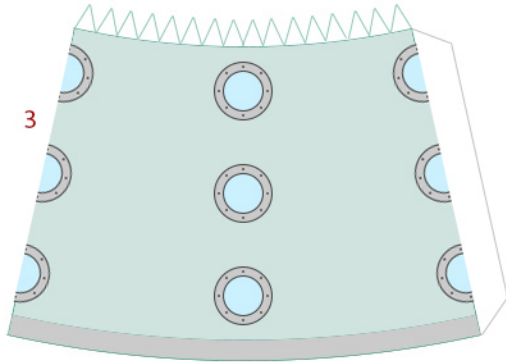
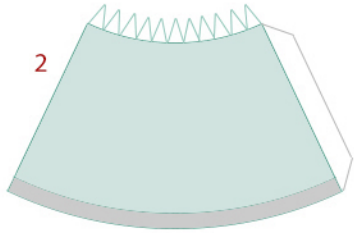
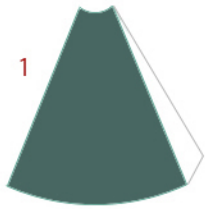

Color back Black

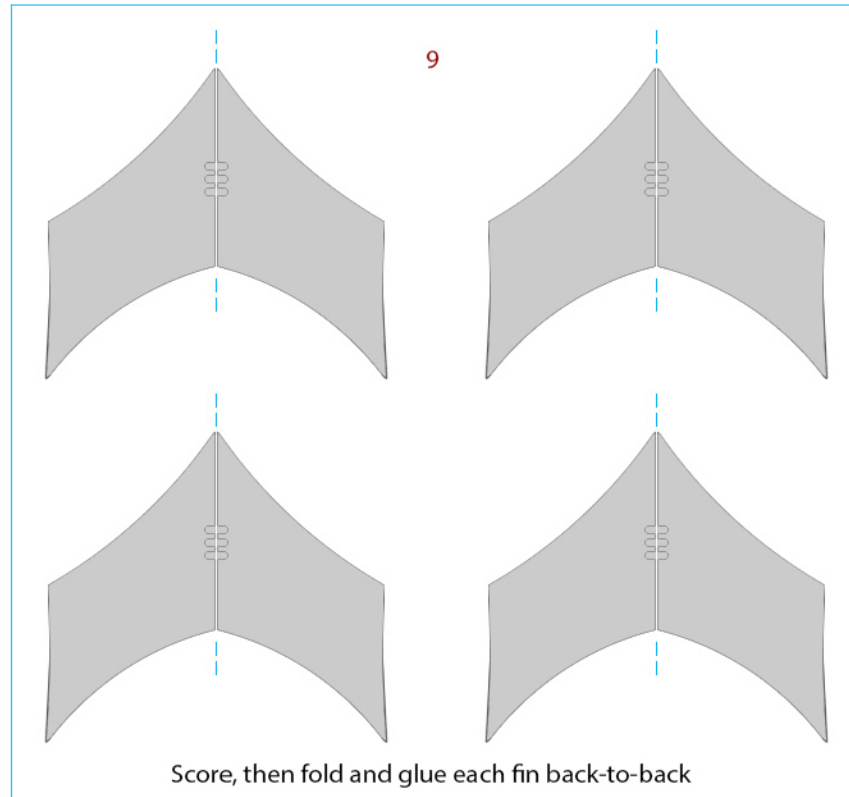

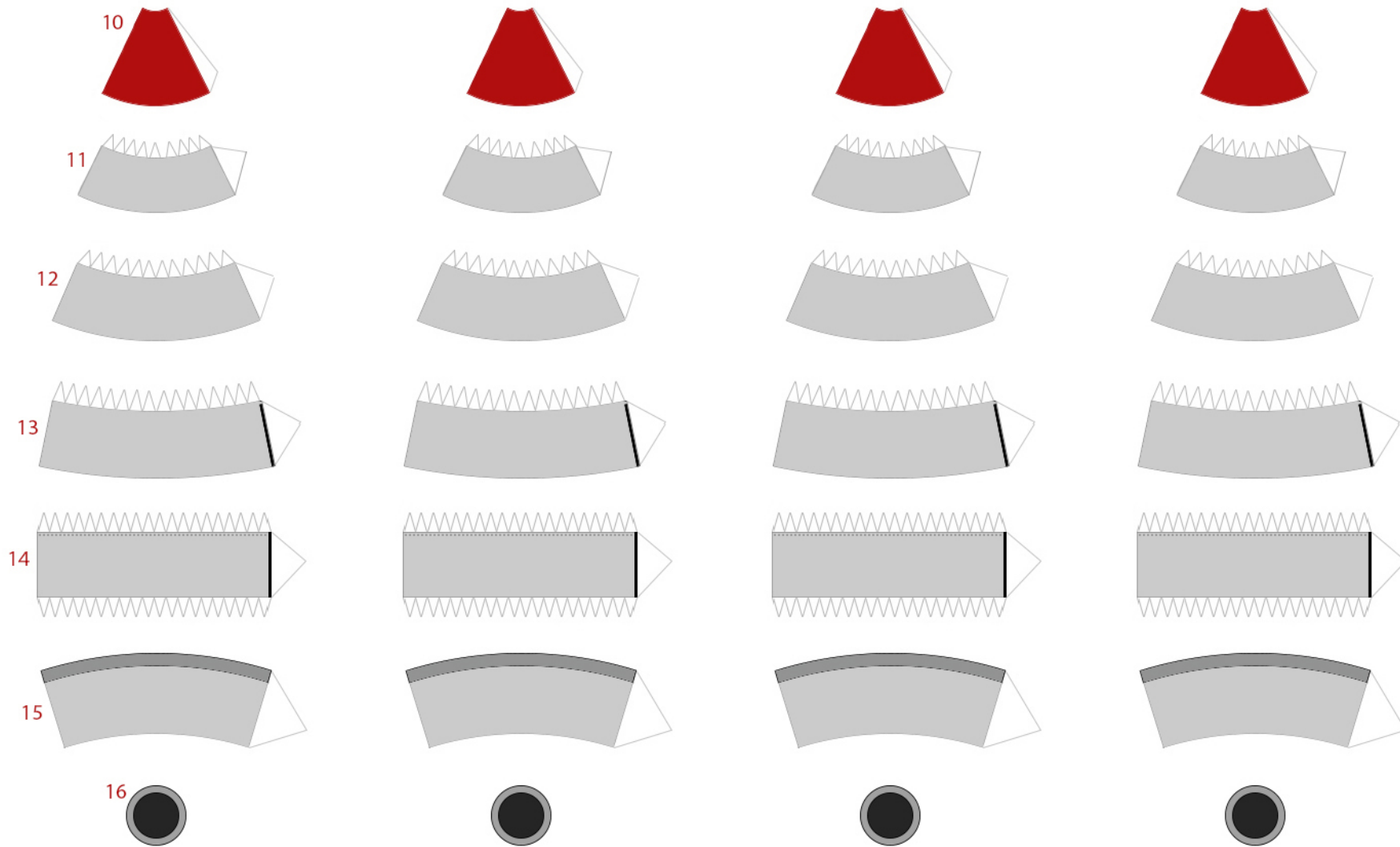

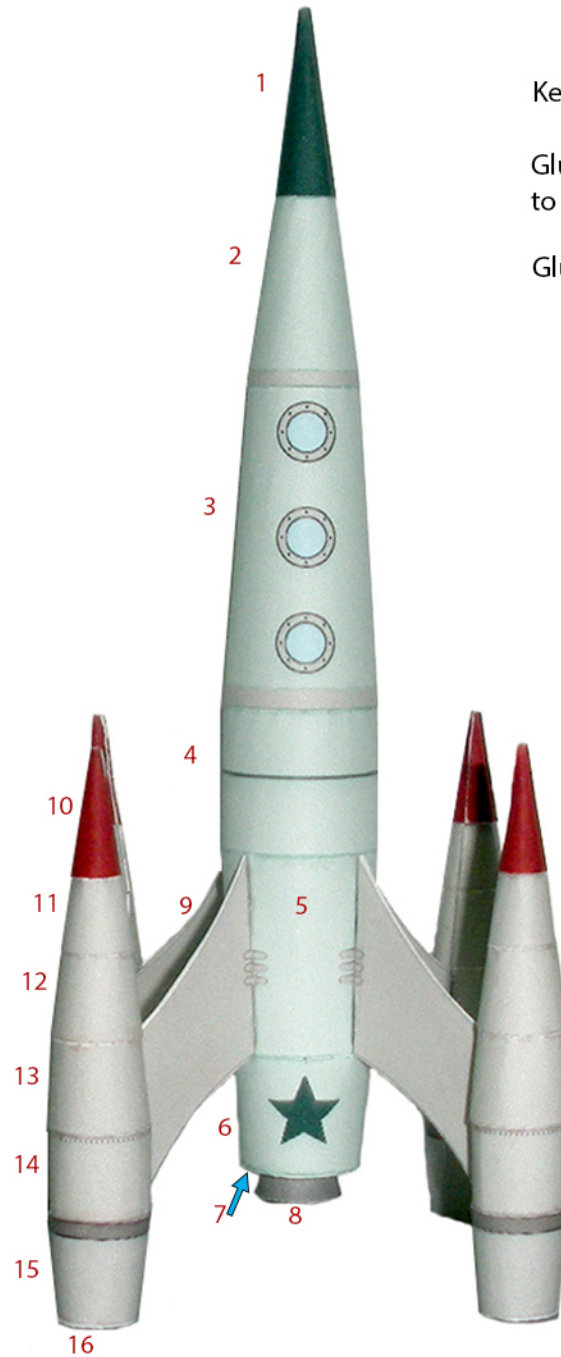

Keep all seems together

Glue the fins (Parts 9) onto the black lines next the to seems on Parts 13 - 14 on the Boosters.

Glue onto the black lines on Parts 5 as shown.

Retro Rocket Ship 55

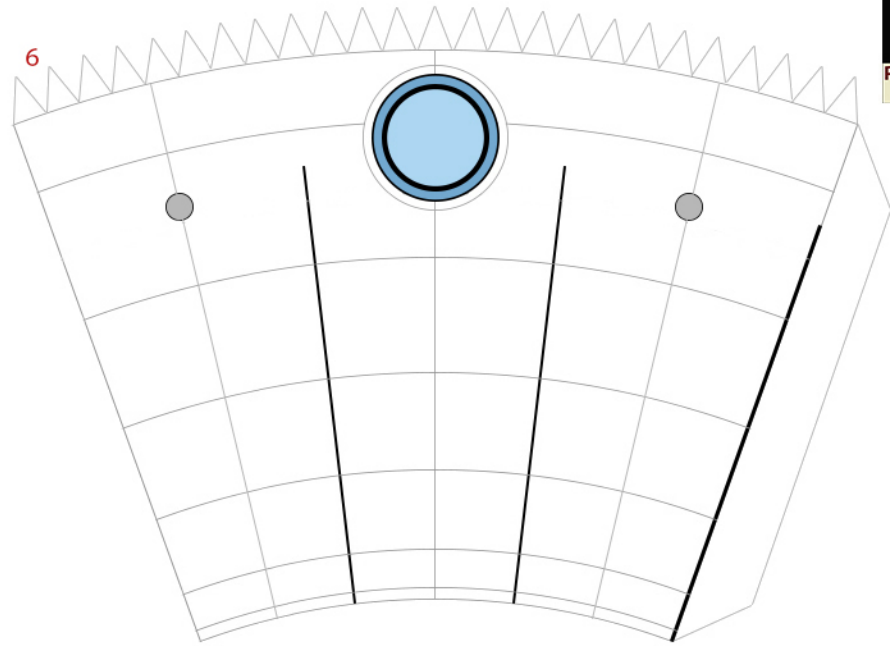
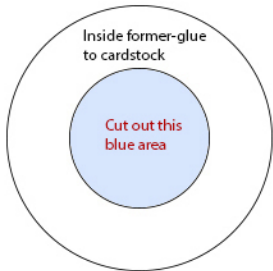
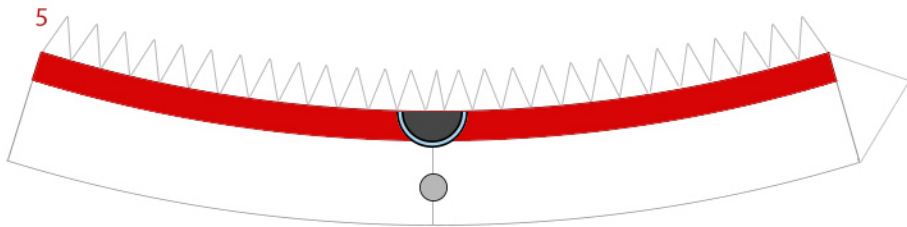
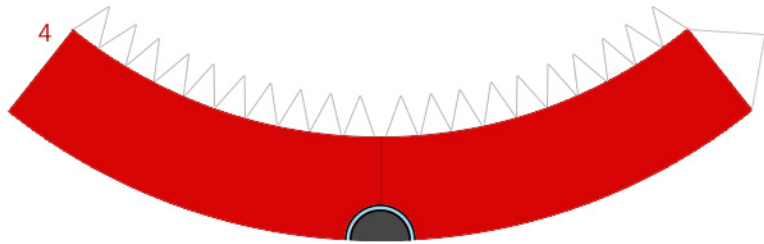
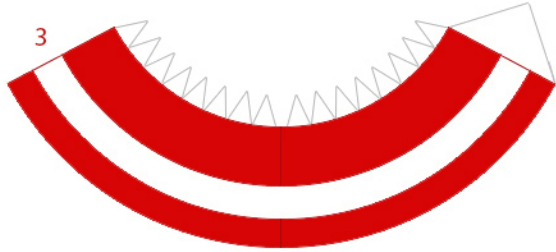
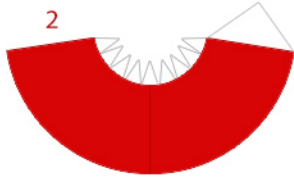

fits inside part above

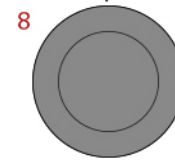

Glue to cardstock

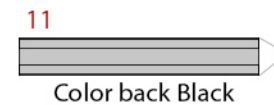
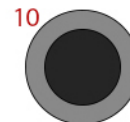

Retro Rocket Ship 55

12

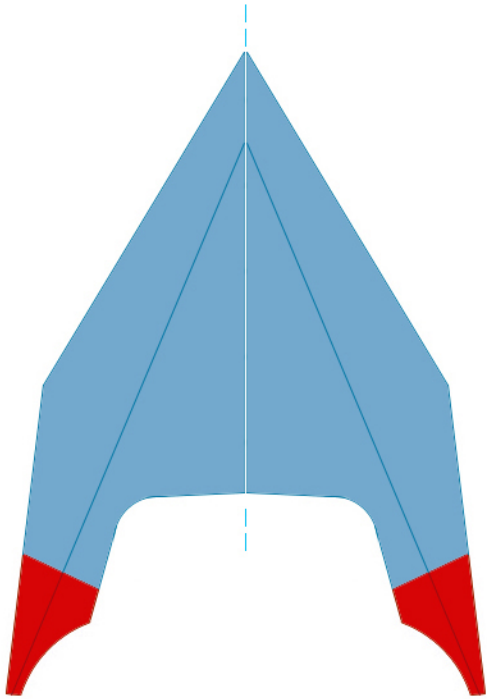
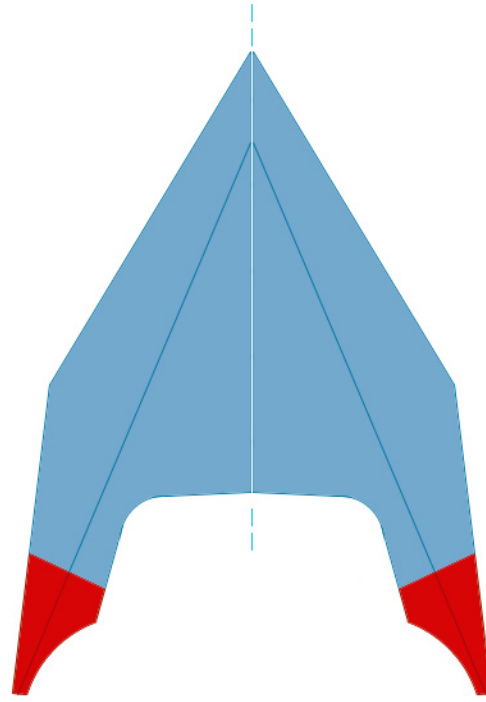
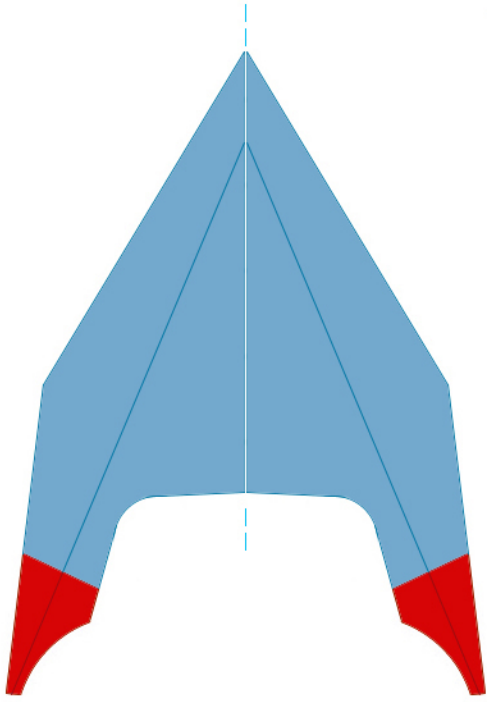

Score, fold and glue each
back-to-back at the blue lines

Retro Rocket Ship 55 Metal texture version

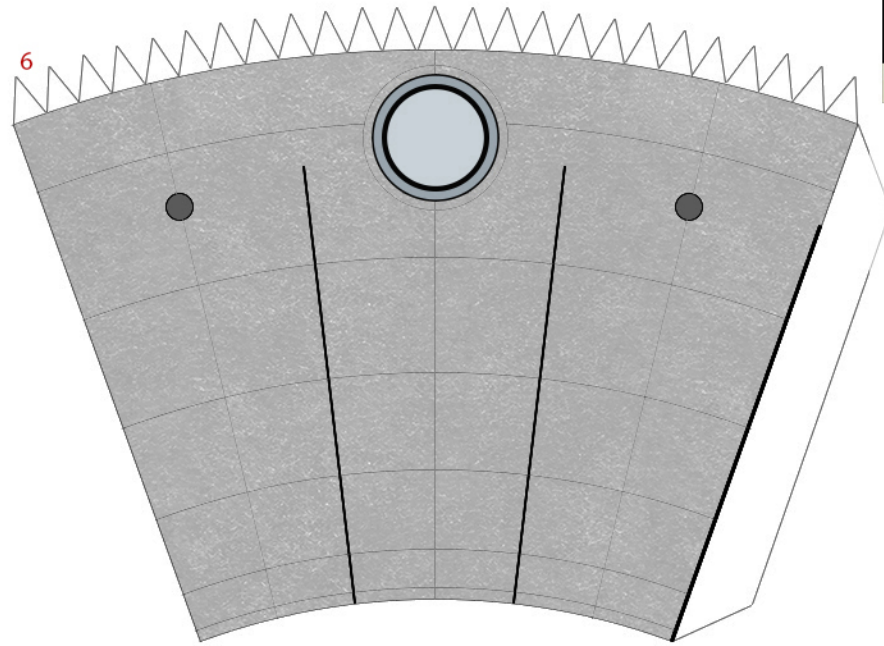
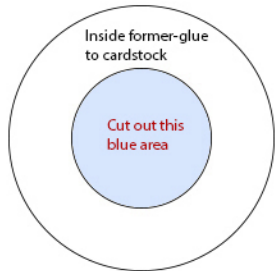
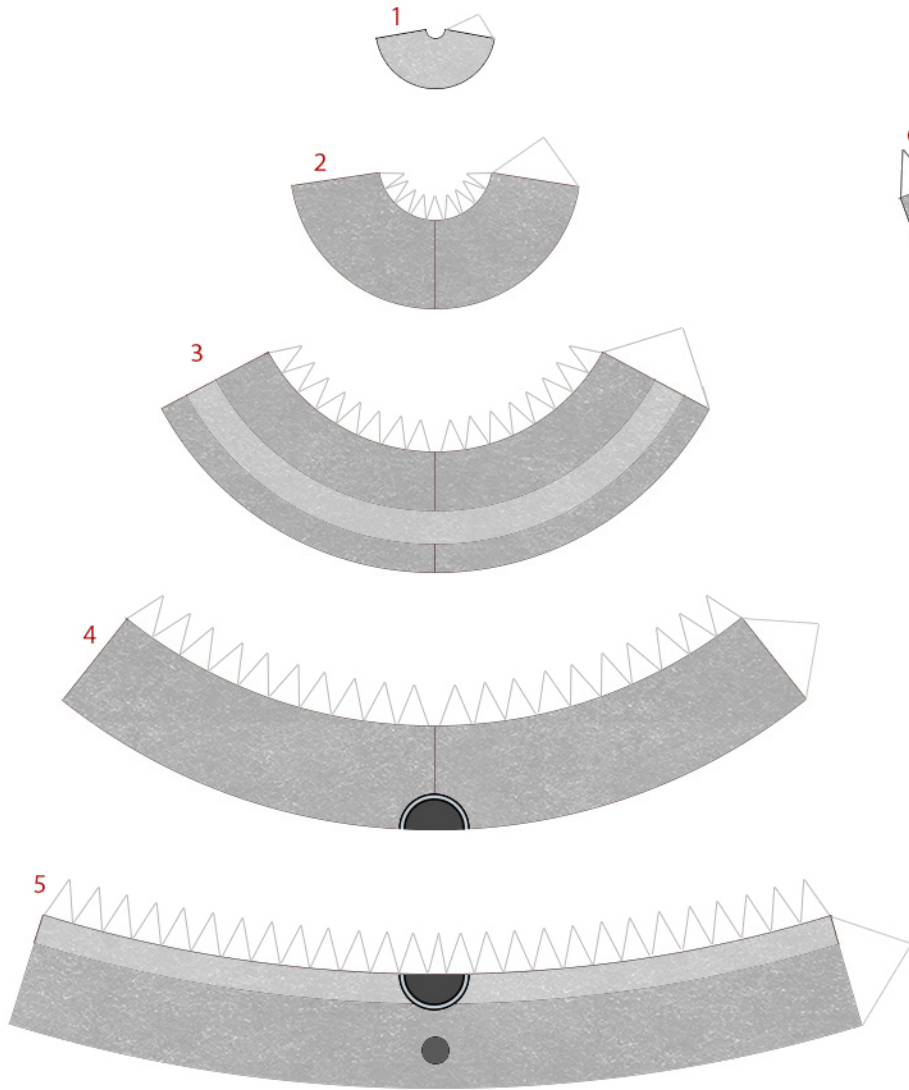

fits inside part above

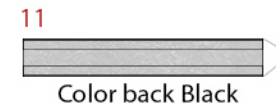
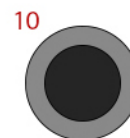
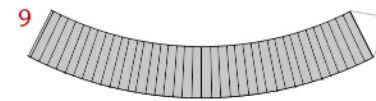
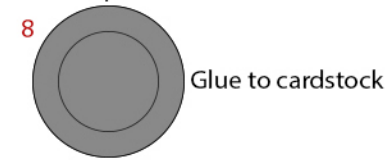

12

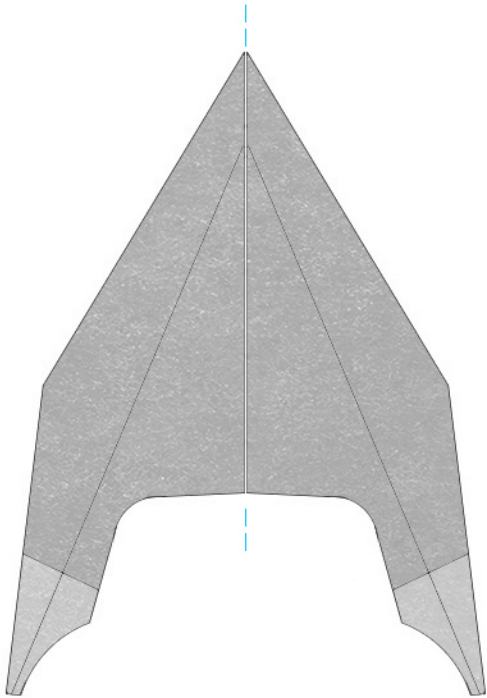
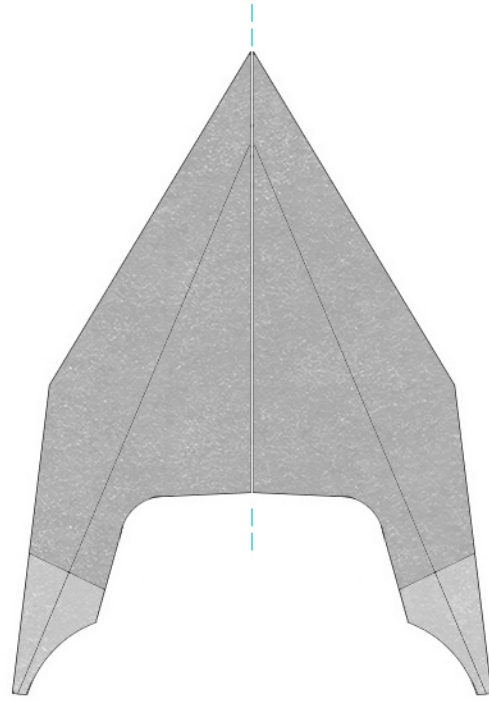
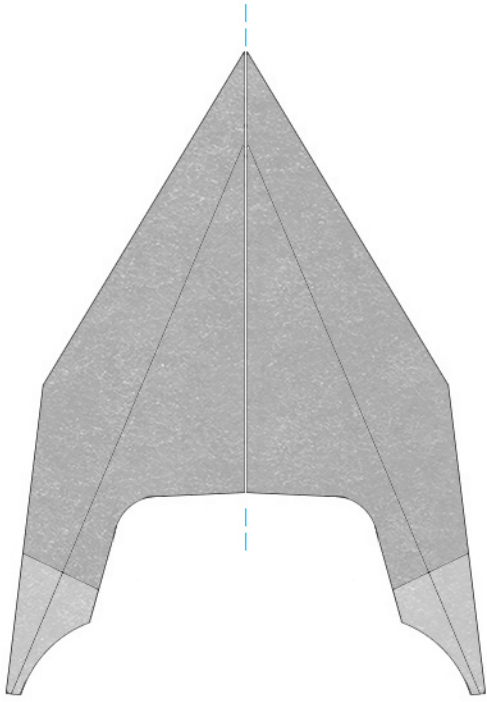

Score, fold and glue each
back-to-back at the blue lines

Retro Rocket Ship 55

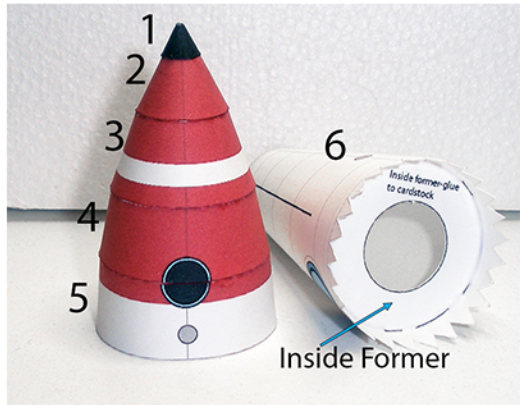

Keep all seems together
Former fits inside of Part 6
under the glue tabs

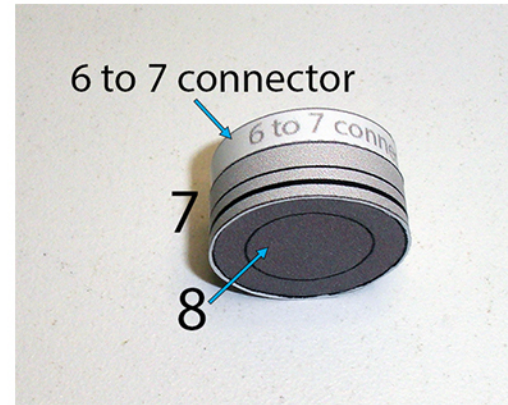
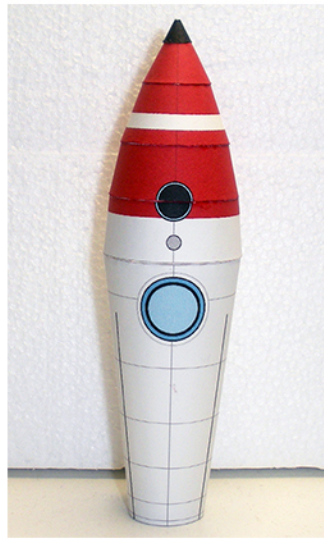

8 fits inside bottom of Part 7

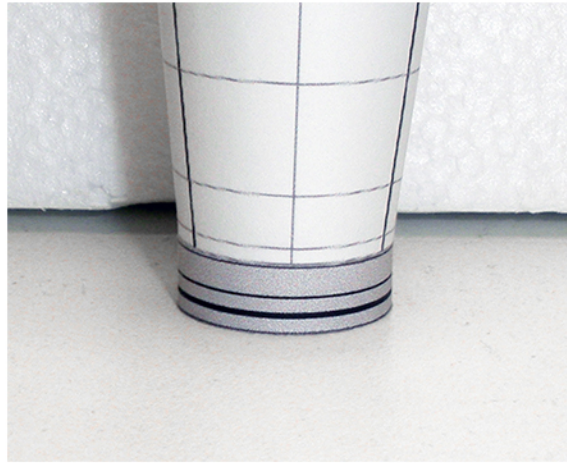

Slide into the bottom of Part 6

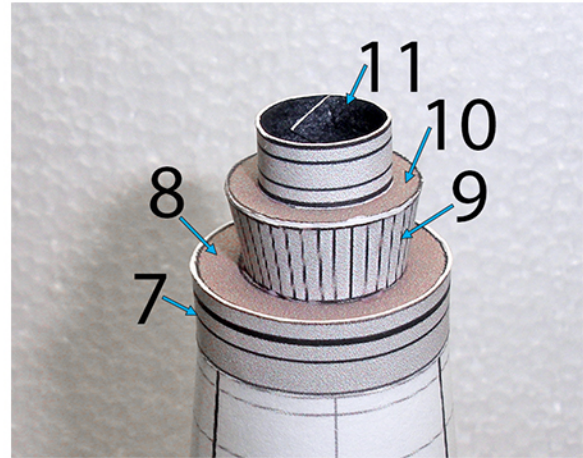

Retro Rocket Ship 56

Interstellar Space Cruiser

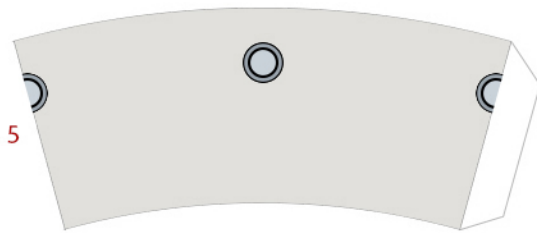
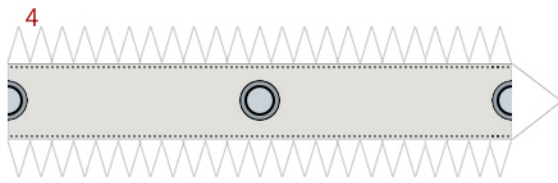
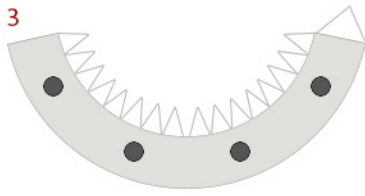
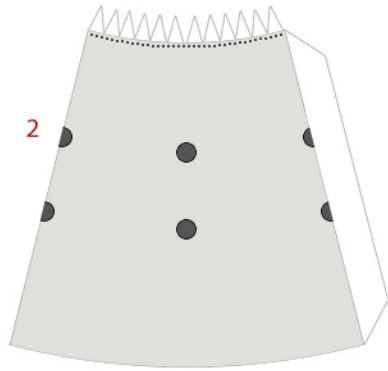
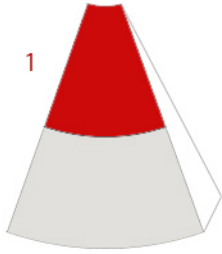

Keep This Red marker at the top

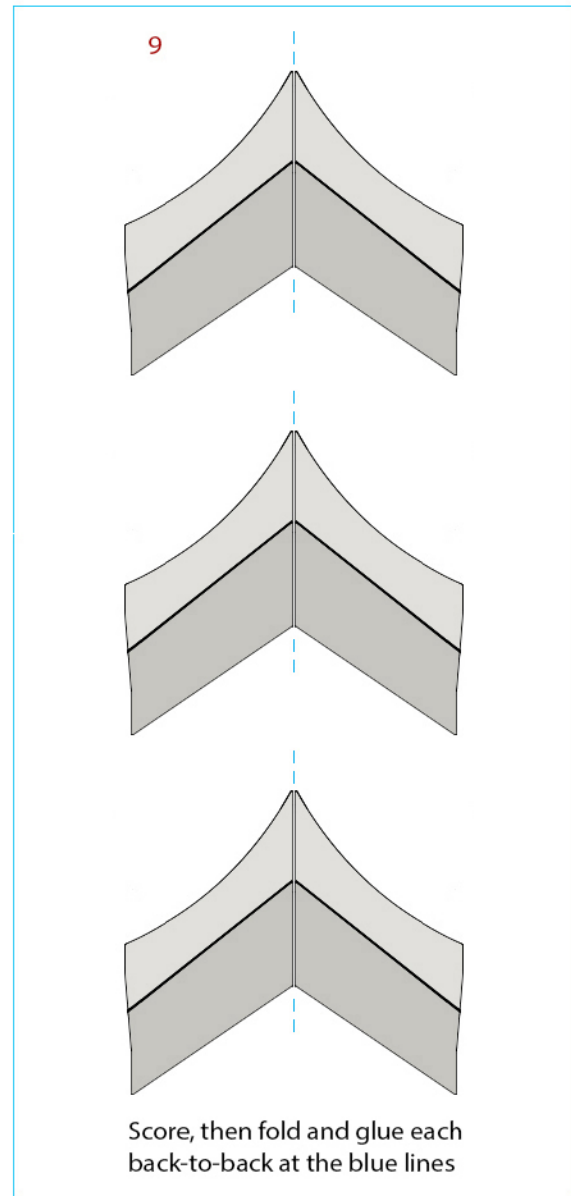
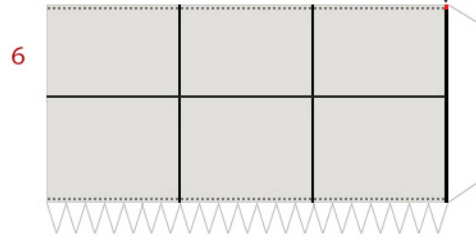

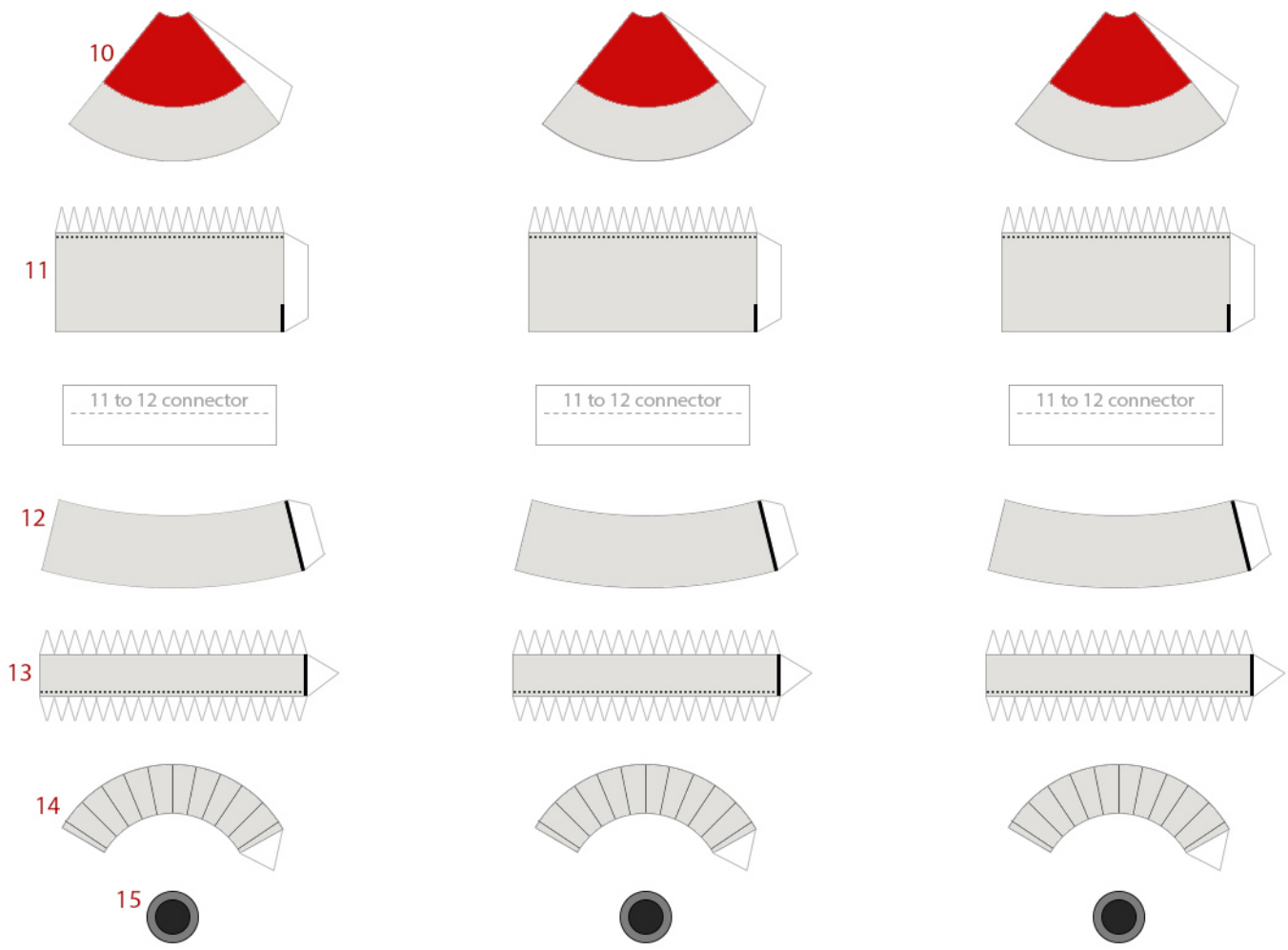

Retro Rocket Ship 56

Interstellar Space Cruiser Metal texture version

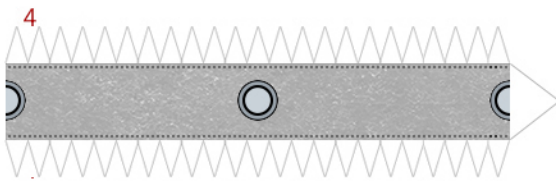
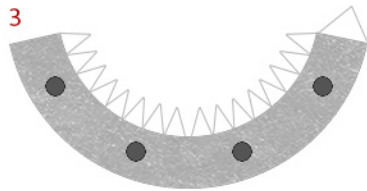
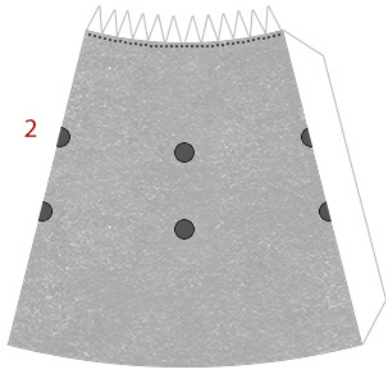
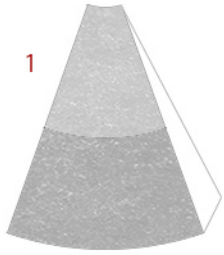

Keep This Red marker at the top

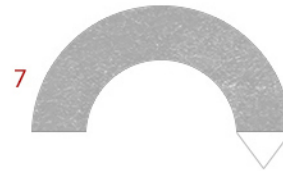
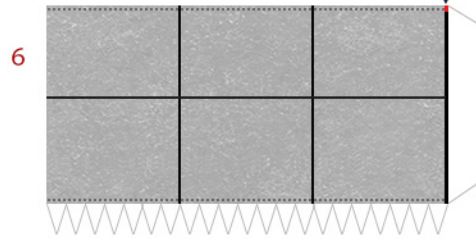

9

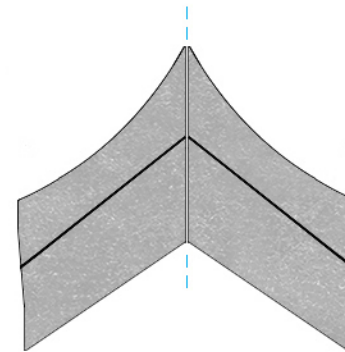
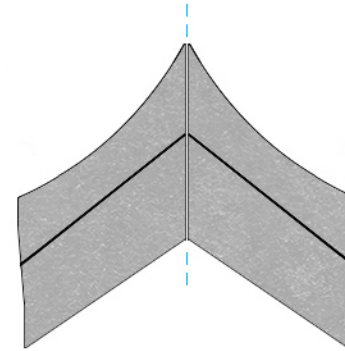
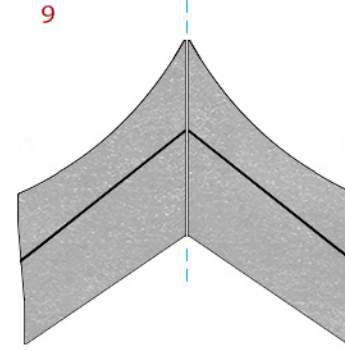

Score, then fold and glue each back-to-back at the blue lines

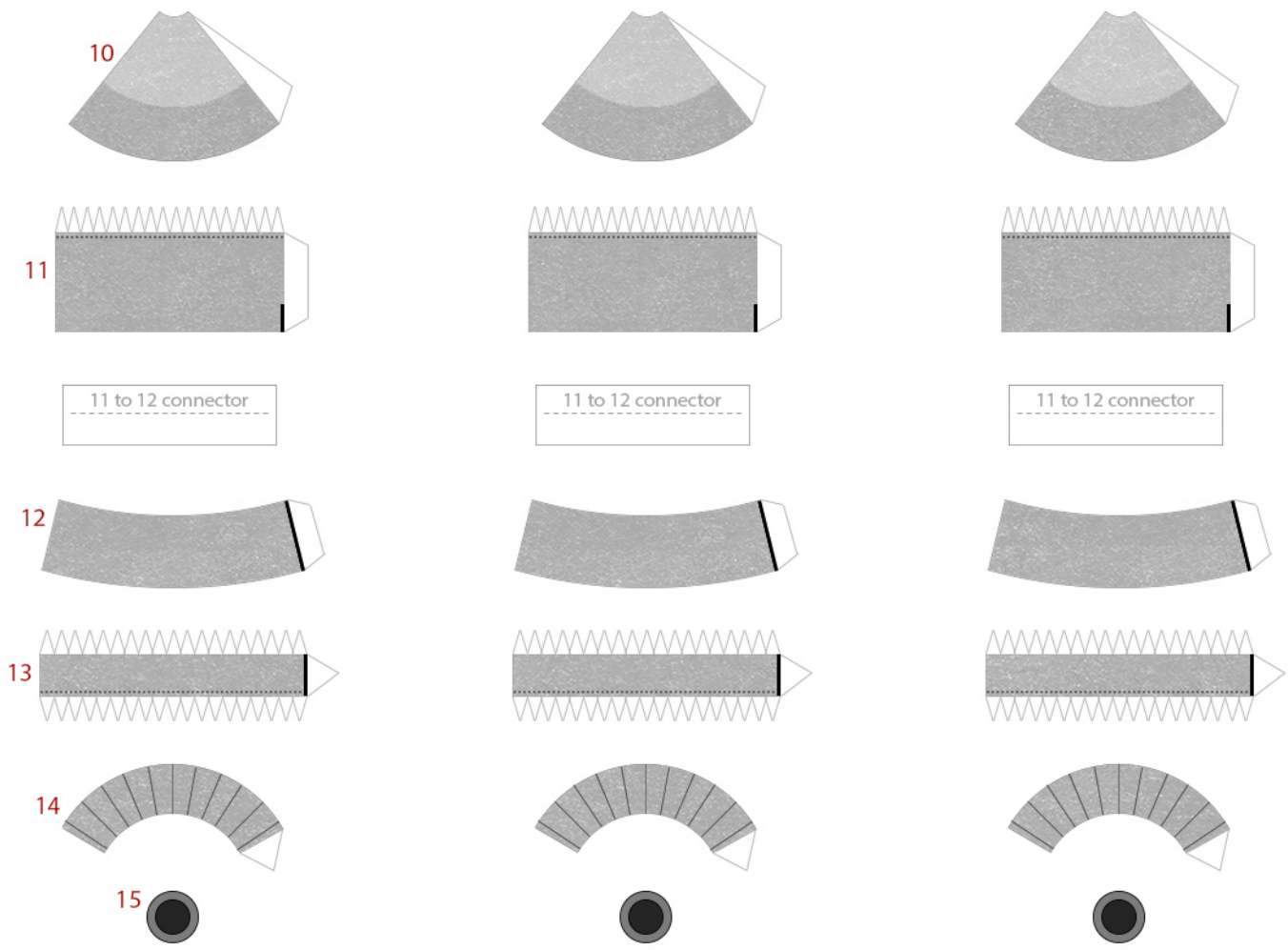

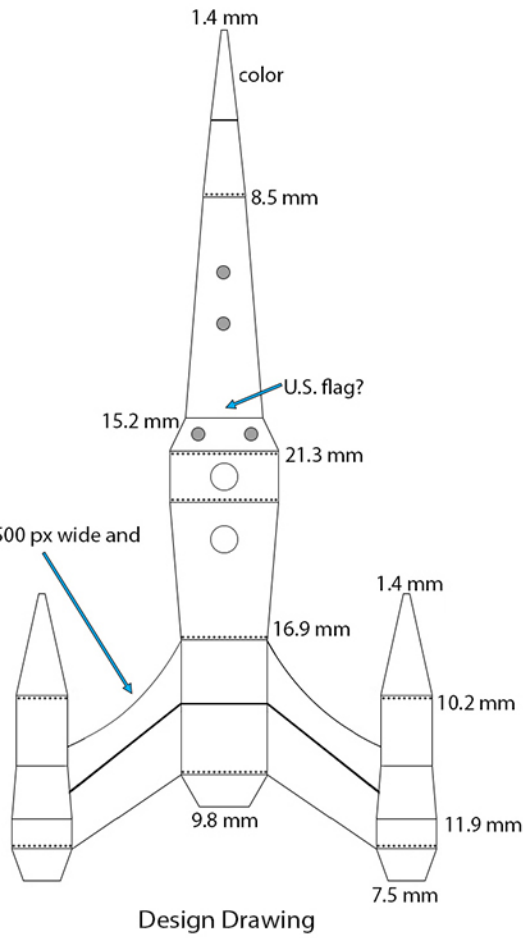

Design Drawing

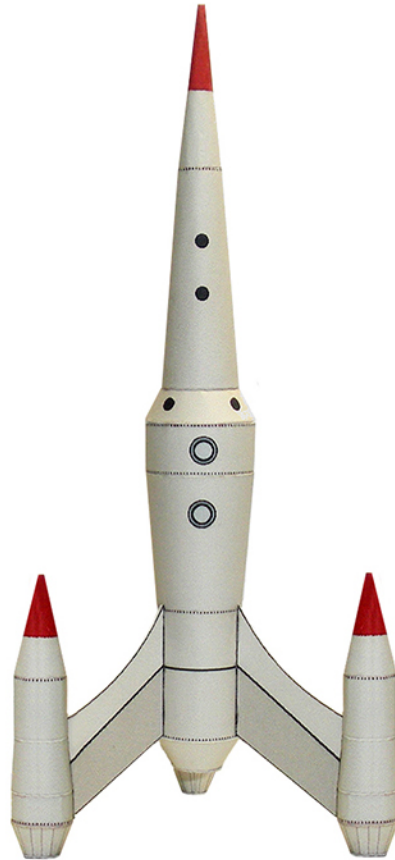

Final Model

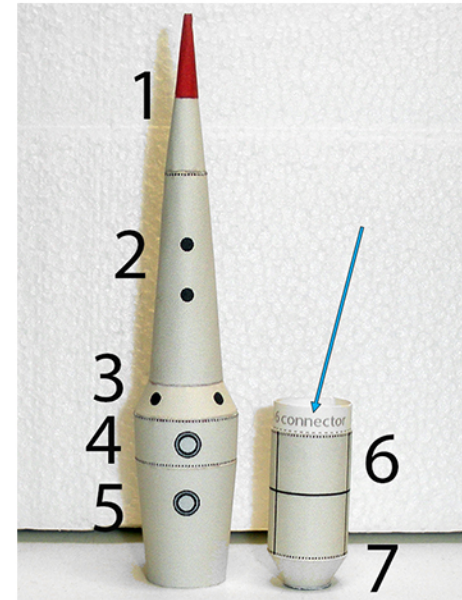

Keep all seems together
8 glues on the bottom of 7

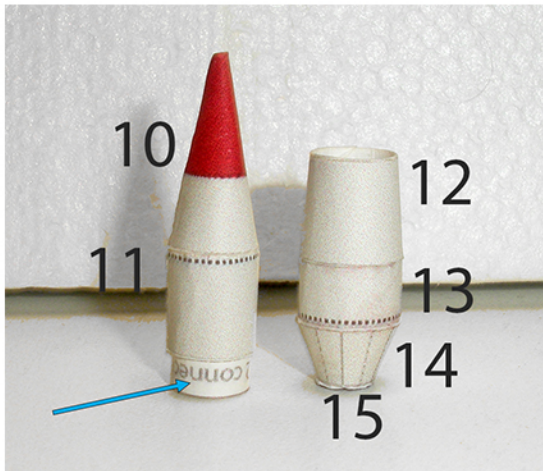

Glue the fins (Parts 9) onto the
Black lines at the seems on the
boosters.

Then glue onto the three (3) black
lines on the body

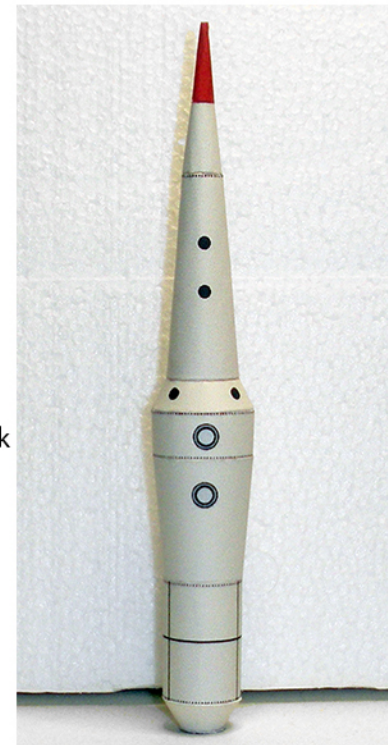

Retro Rocket Ship 57

Black version

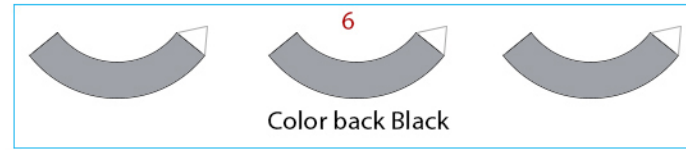
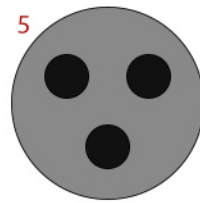
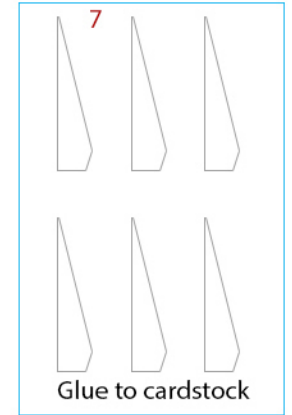
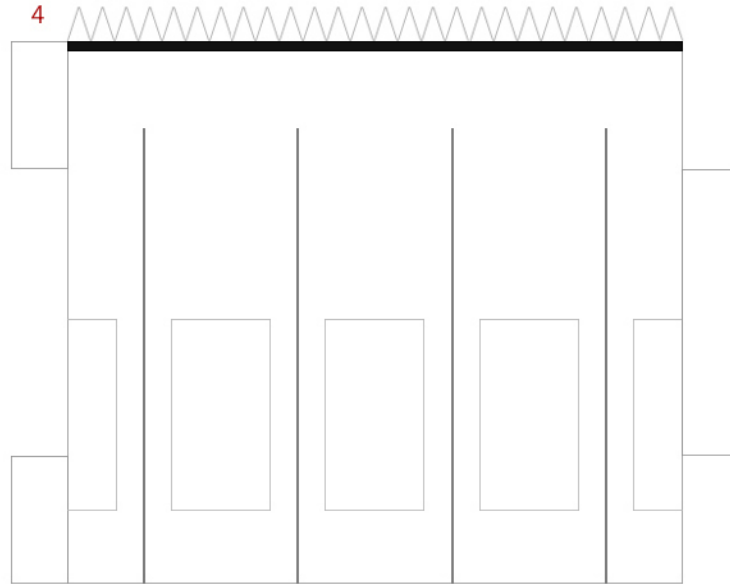
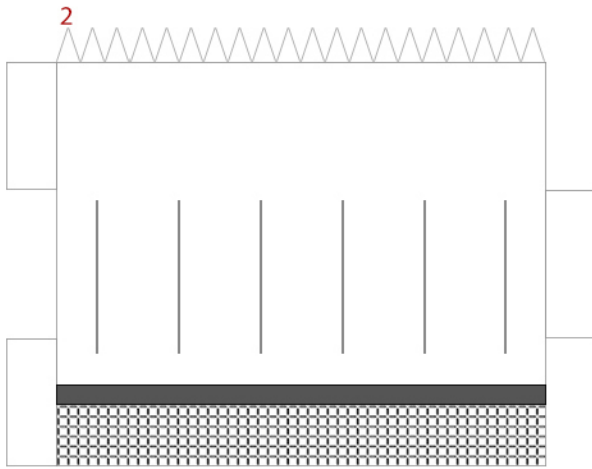
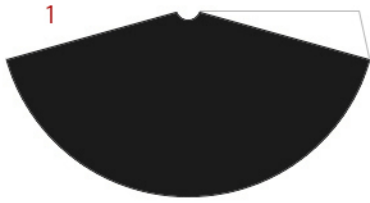

Glue to cardstock, fits inside bottom of Part 4 above

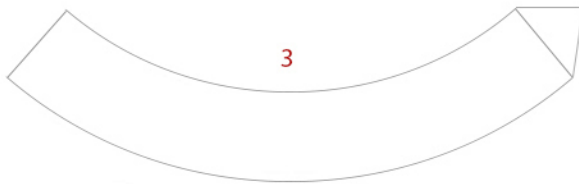

8
score, fold and glue each fin back-to-back

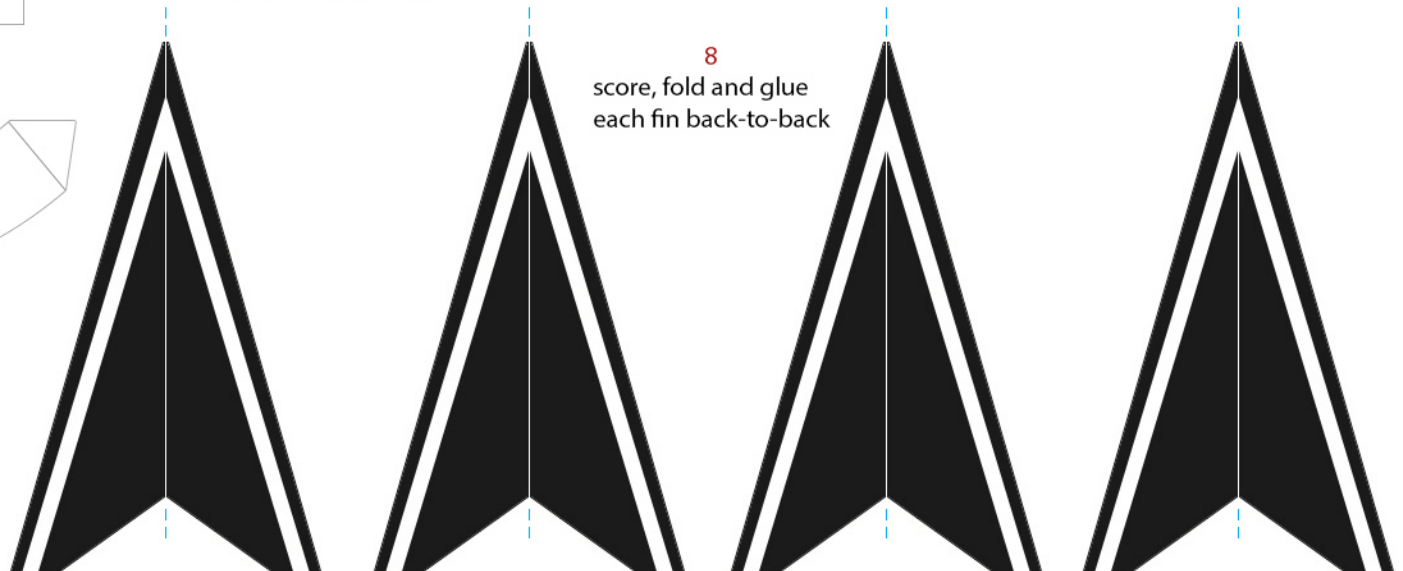

Retro Rocket Ship 57

Blue version

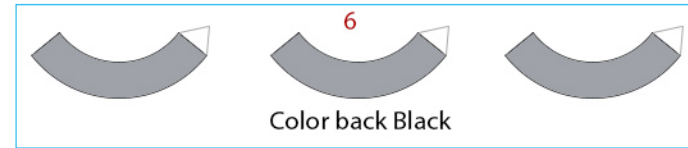
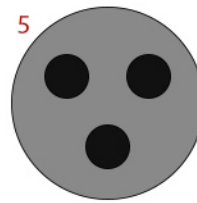
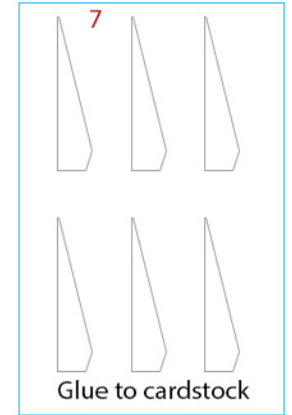
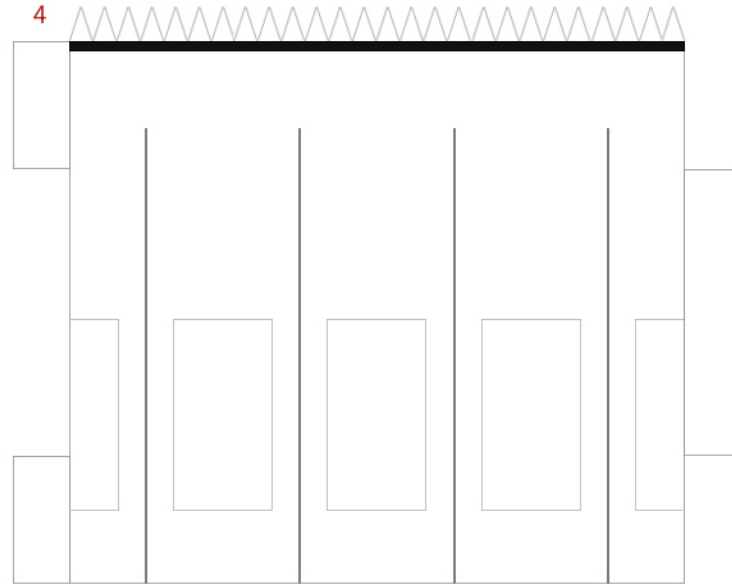
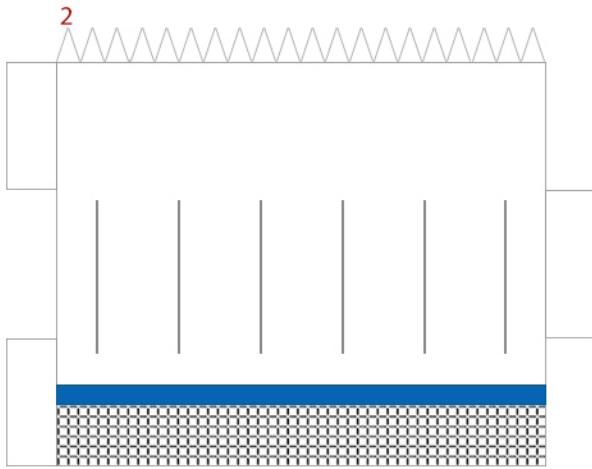
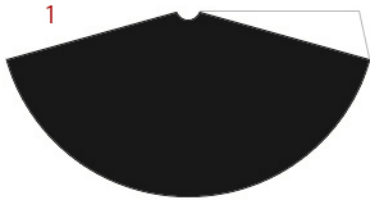

Glue to cardstock, fits inside bottom of Part 4 above

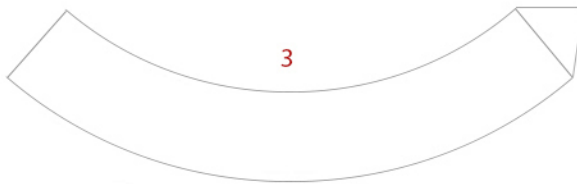

8
score, fold and glue each fin back-to-back

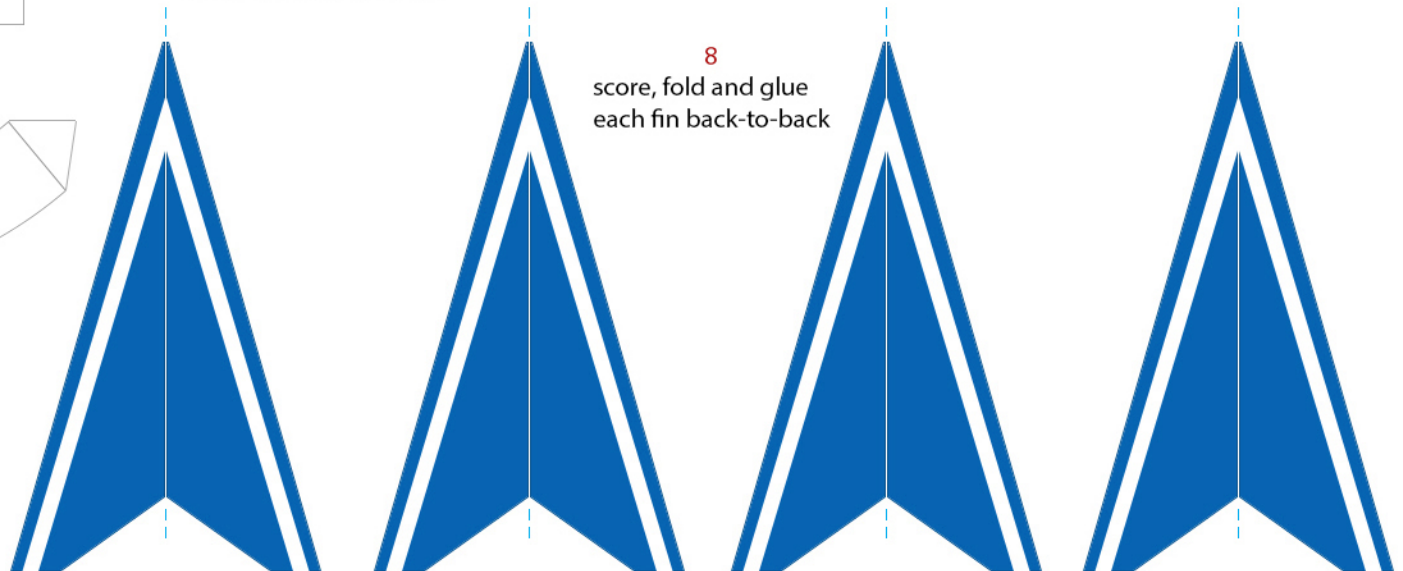

Retro Rocket Ship 57

Red Version

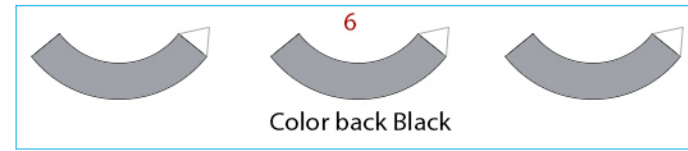
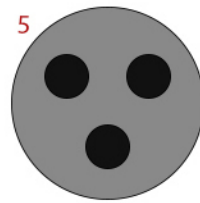
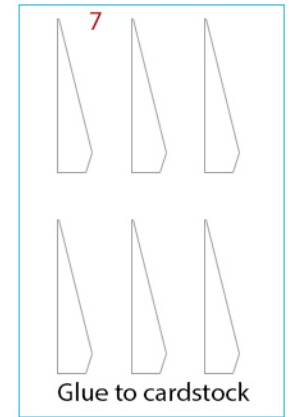
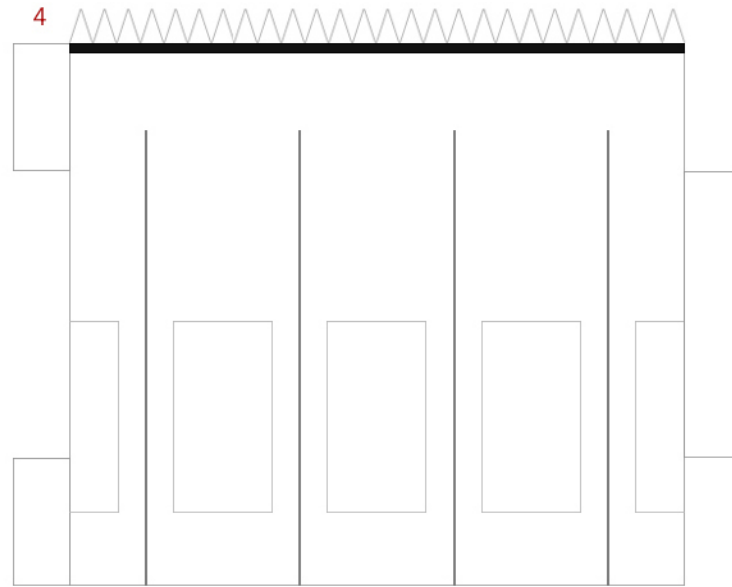
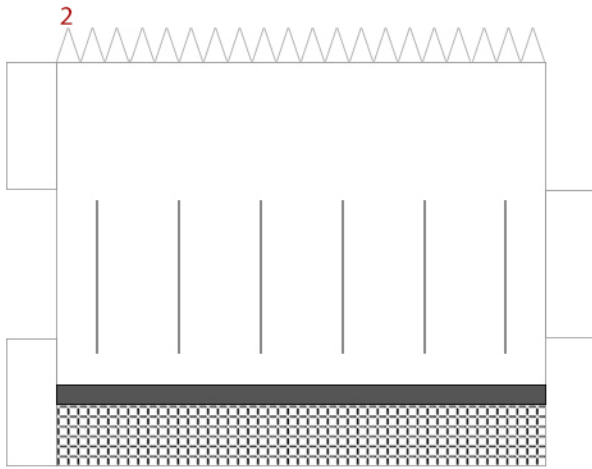
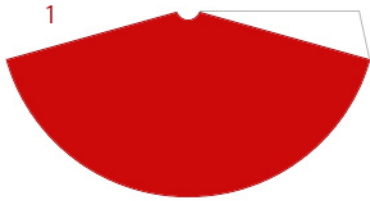

Glue to cardstock, fits inside bottom of Part 4 above

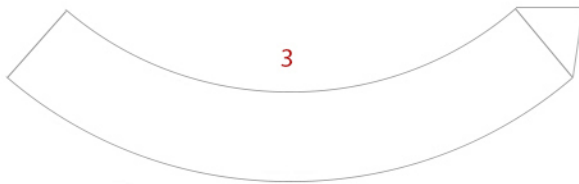

8
score, fold and glue each fin back-to-back

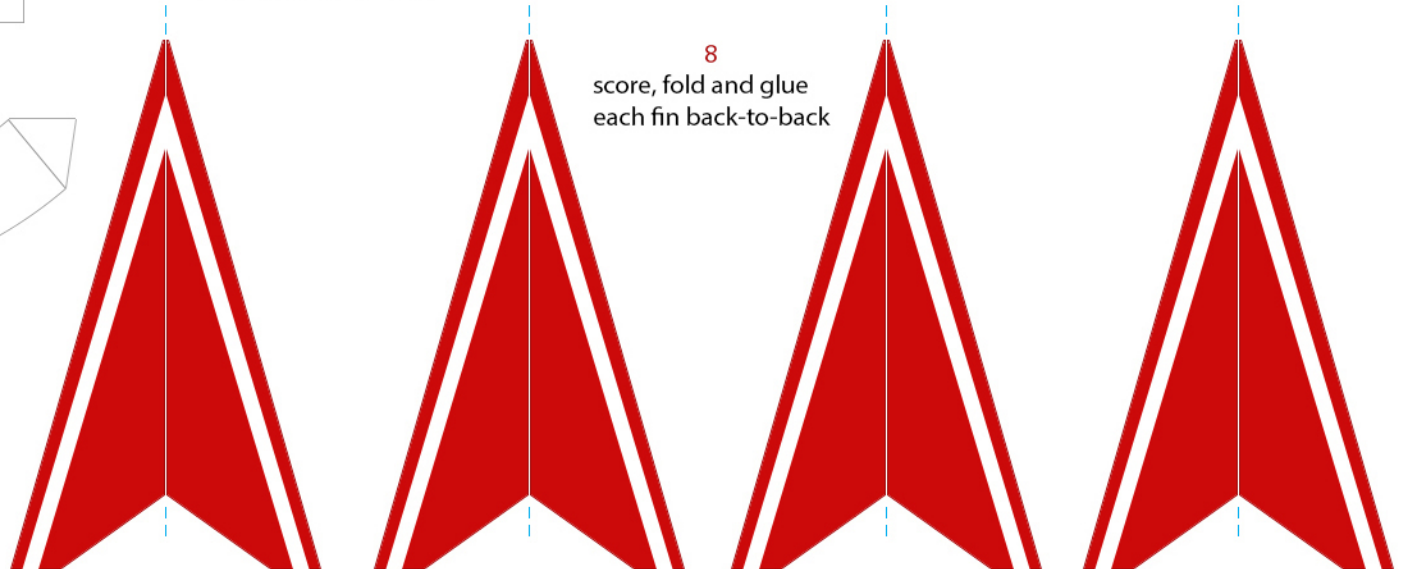

Keep all seems together

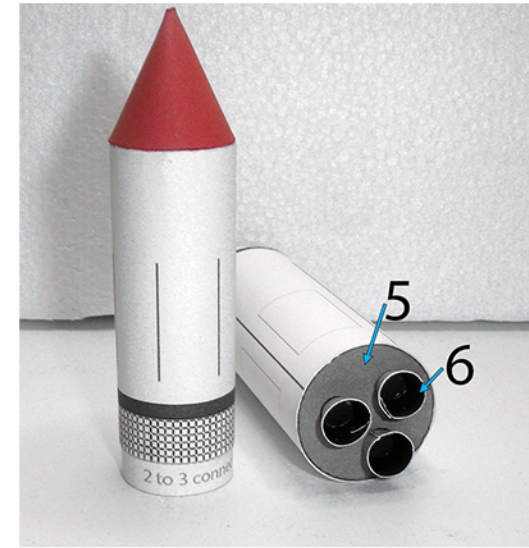
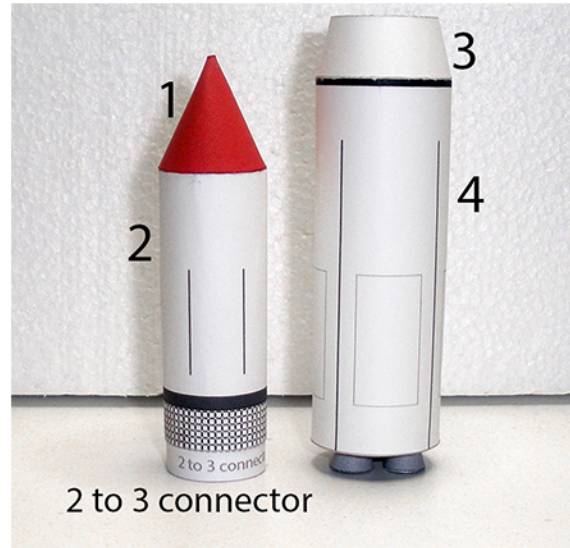
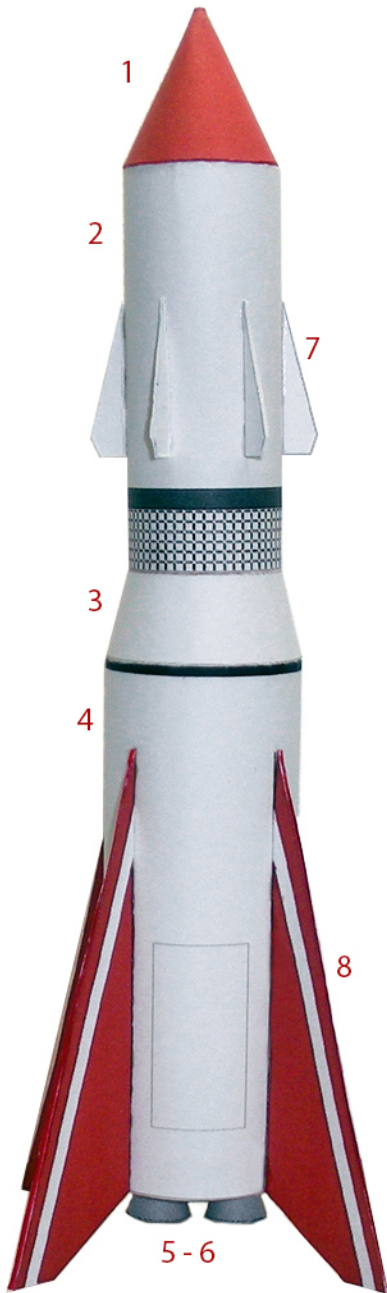

Part 5 fits inside bottom of 4



7 is glued onto the six (6) lines on 2

8 glues onto the four (4) lines on 4

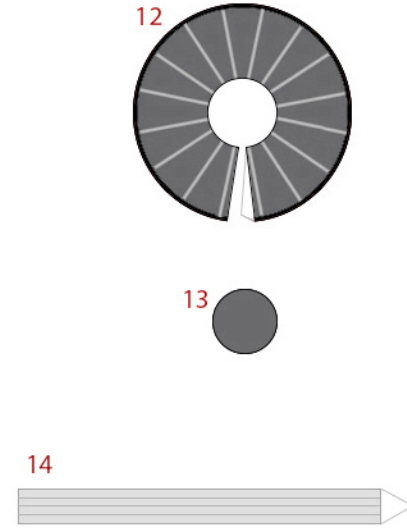
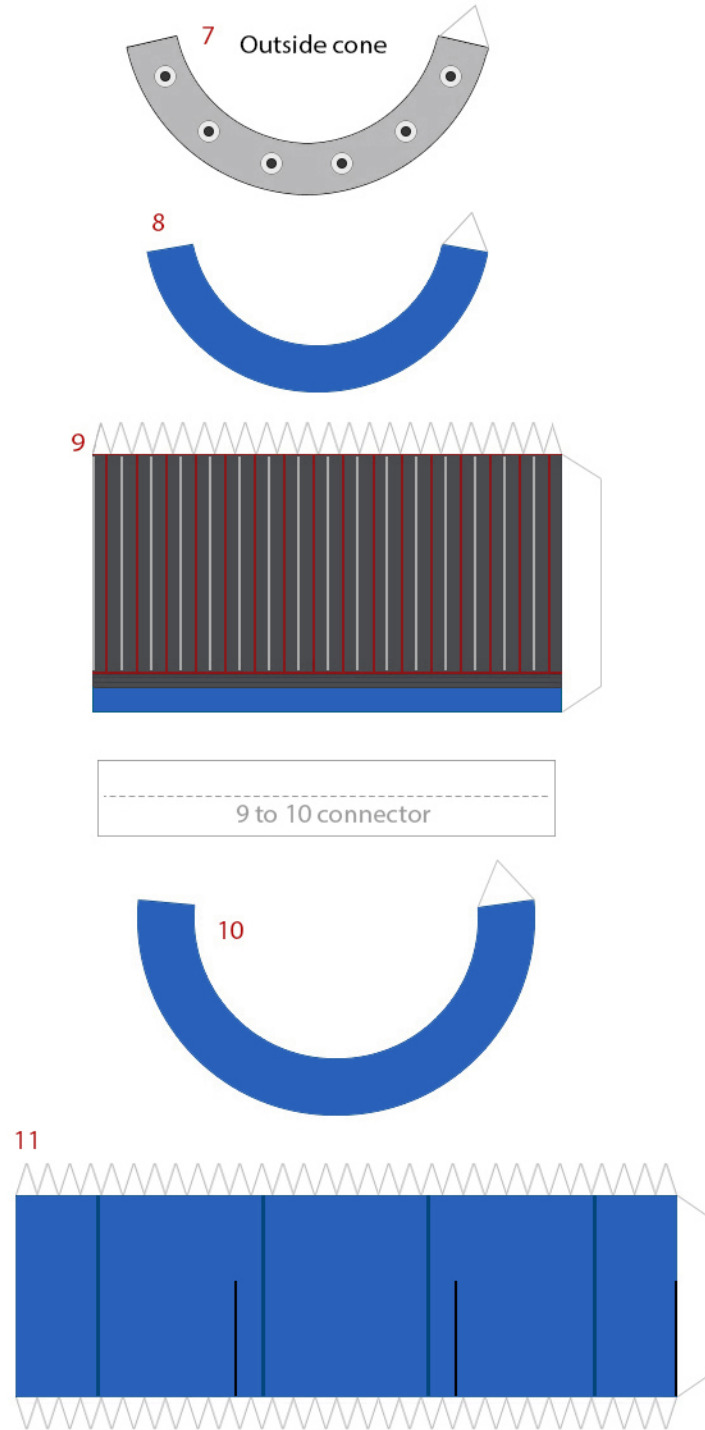
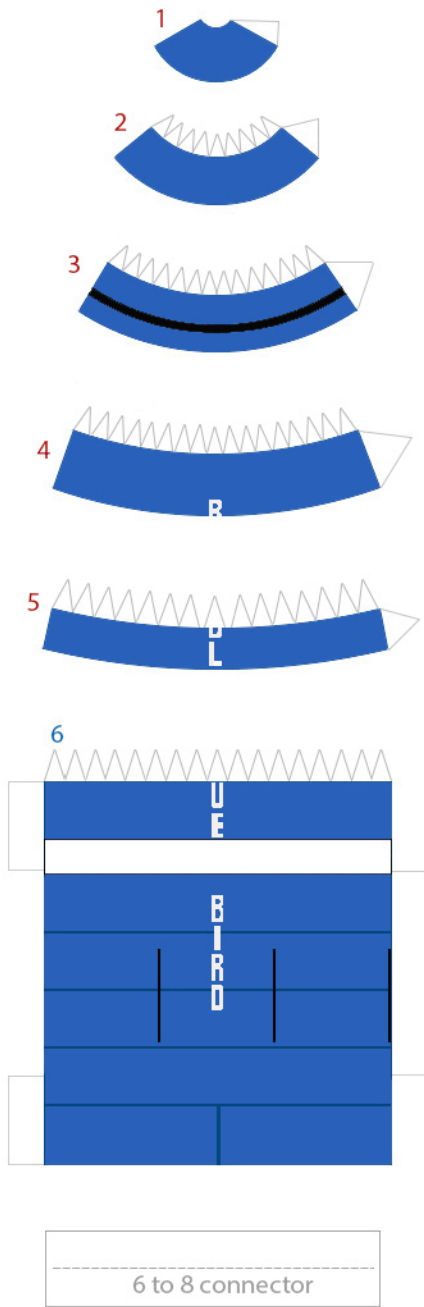

Retro Rocket Ship 58

Blue Bird

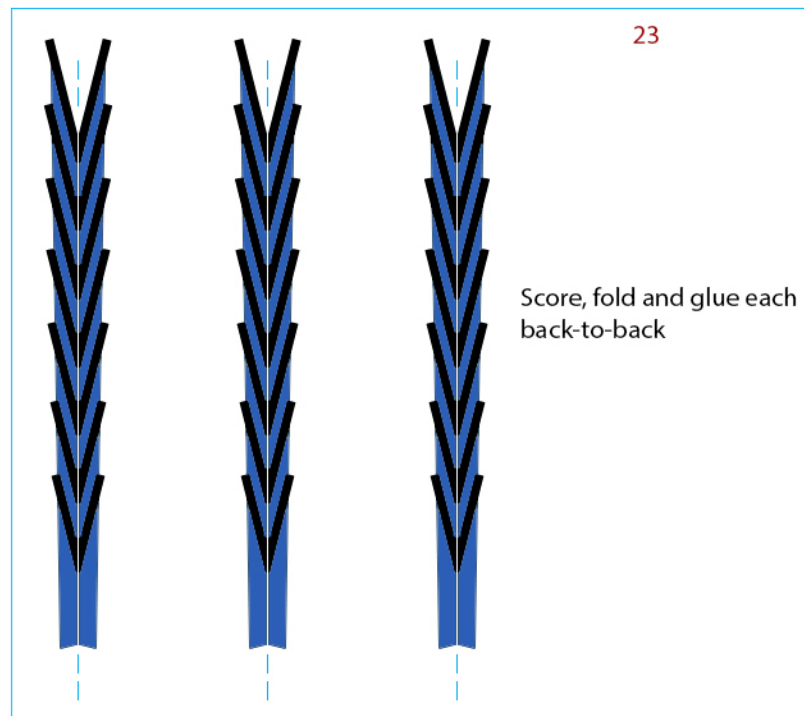
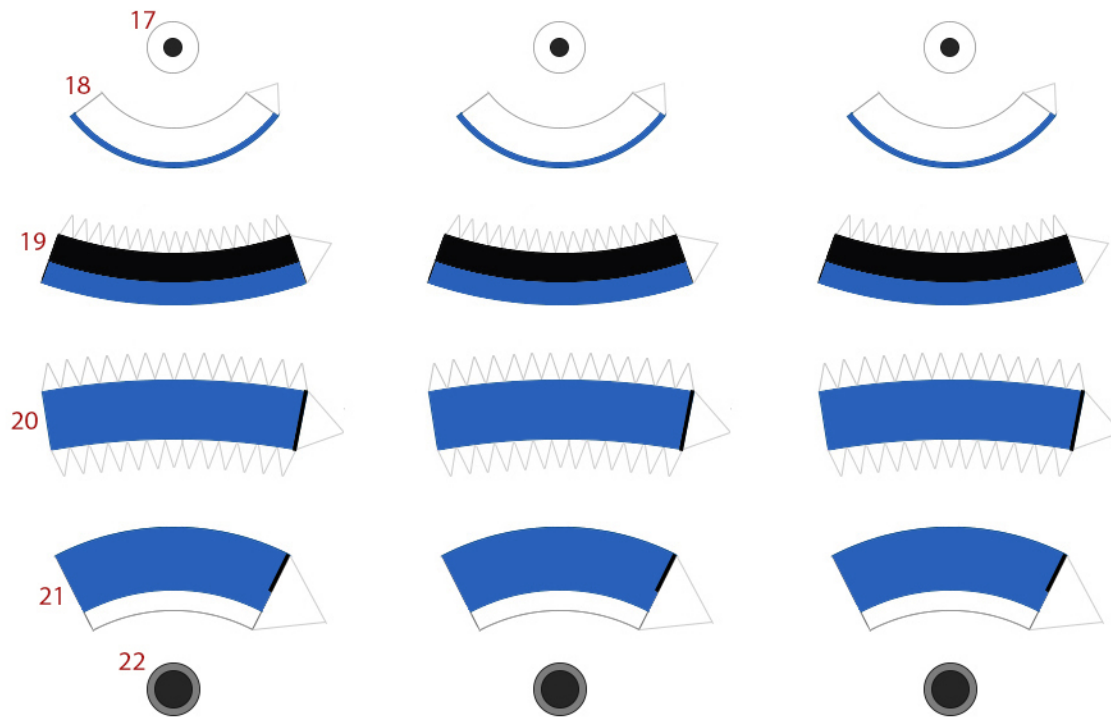
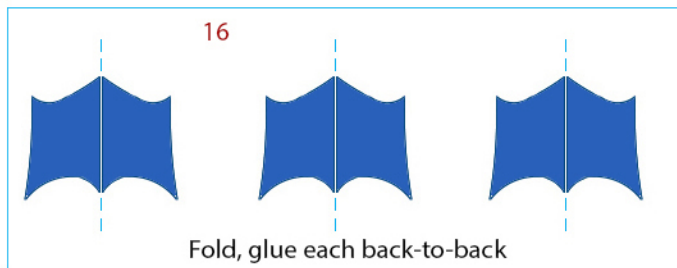
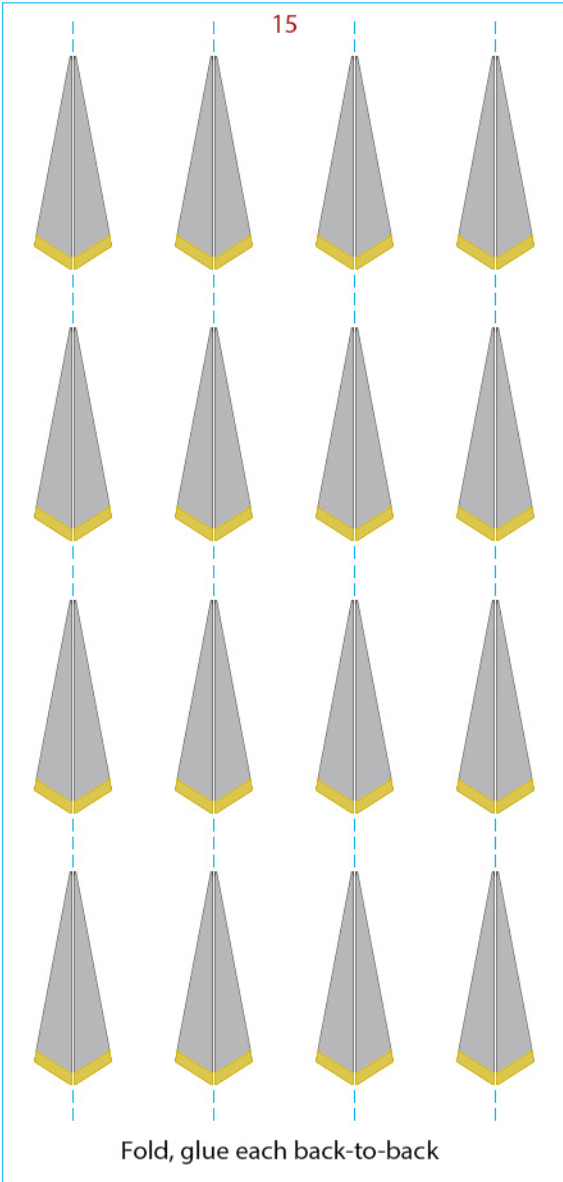

Retro Rocket Ship 58

Grey Ghost

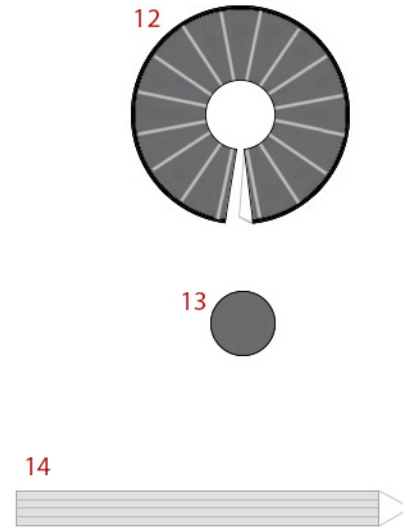
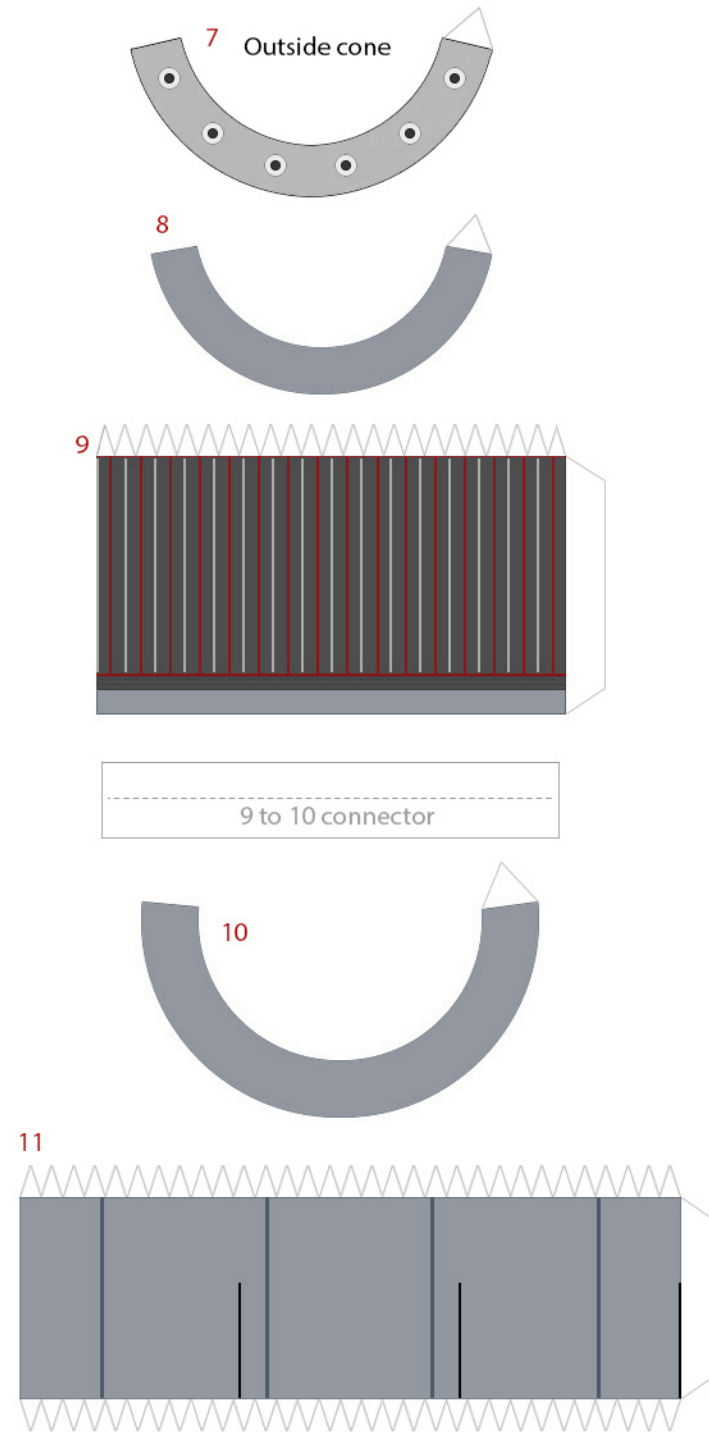
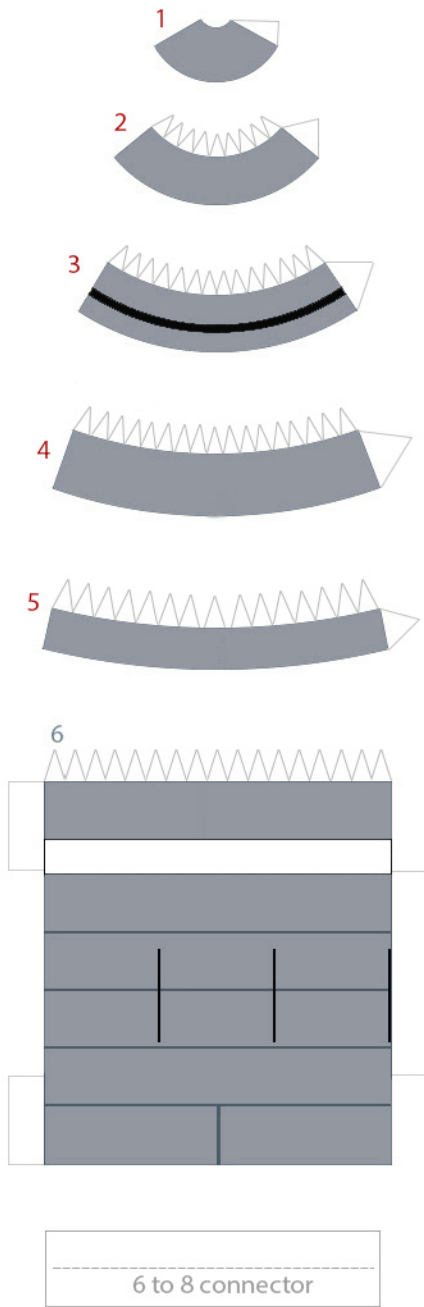

Retro Rocket Ship 58

Grey Ghost

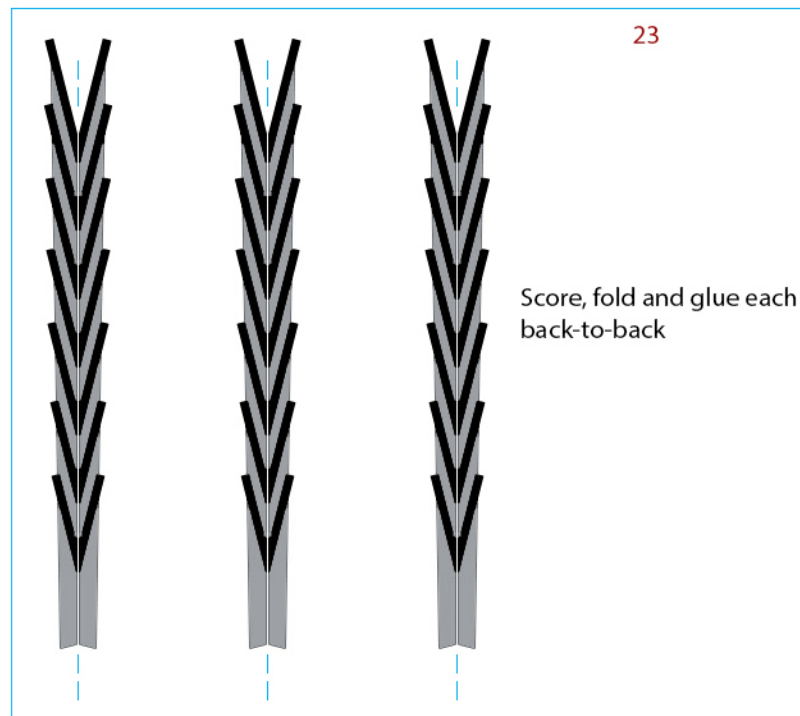
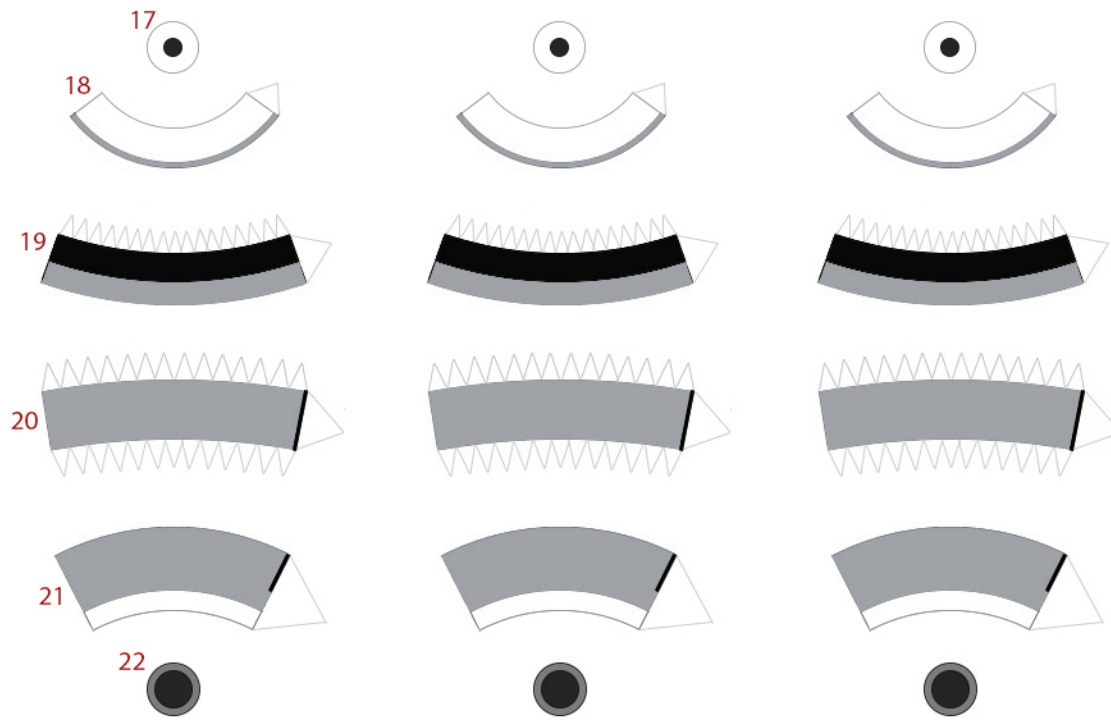
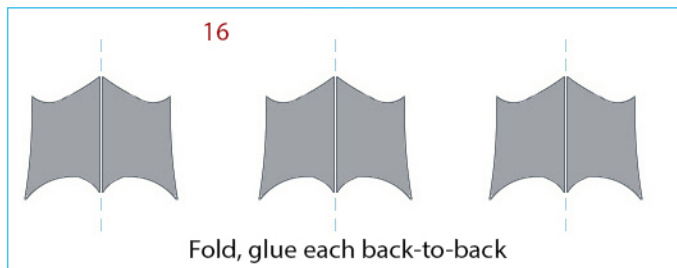
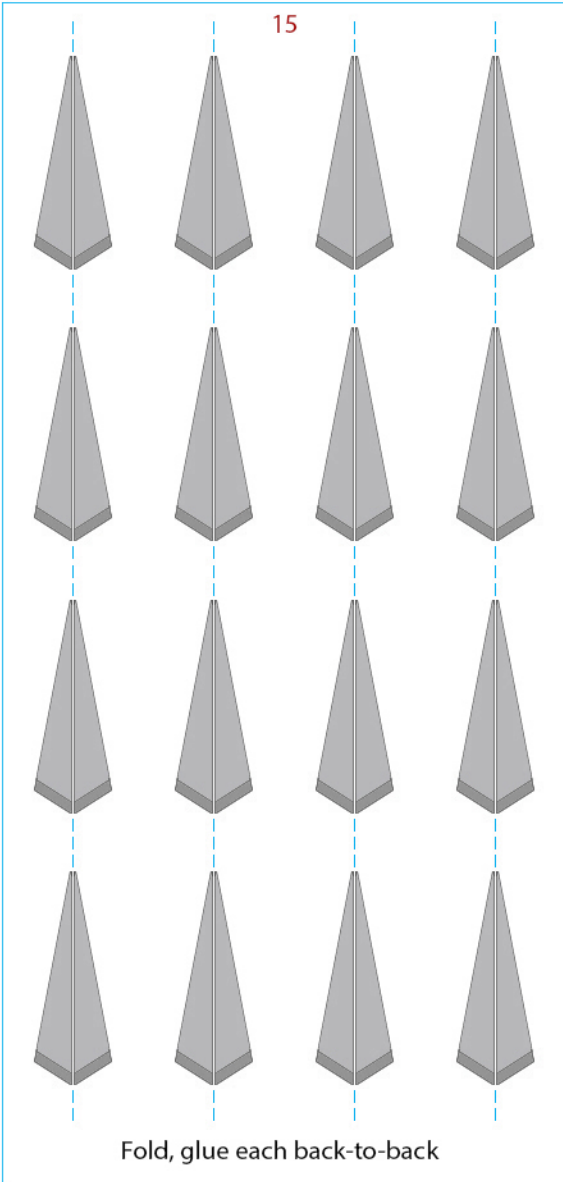

Blue Bird is a variant of the famous Thunderbird 3 retro rocket. This idea came to me while designing a model of Thunderbird 3

Keep all seems together

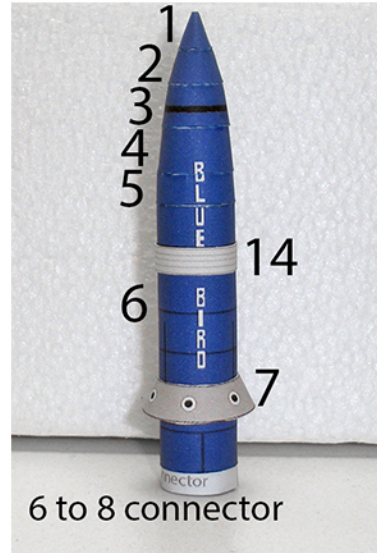

6 to 8 connector

Do Not glue part 7 yet



Glue 8 to the bottom using the connector

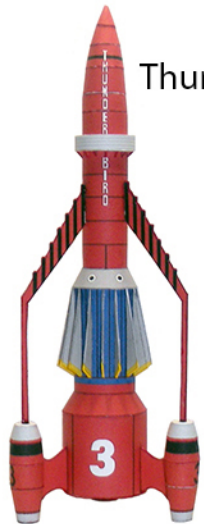

Thunderbird 3

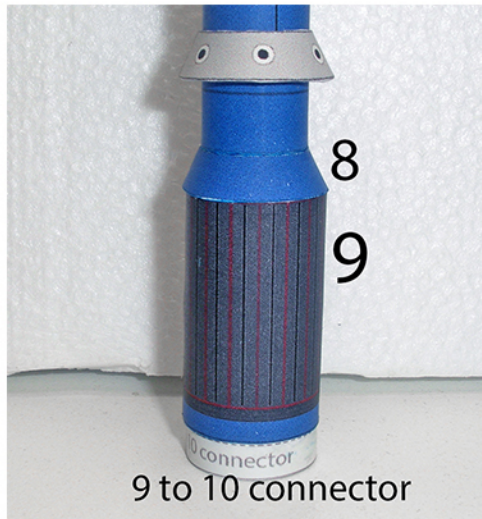

9 to 10 connector

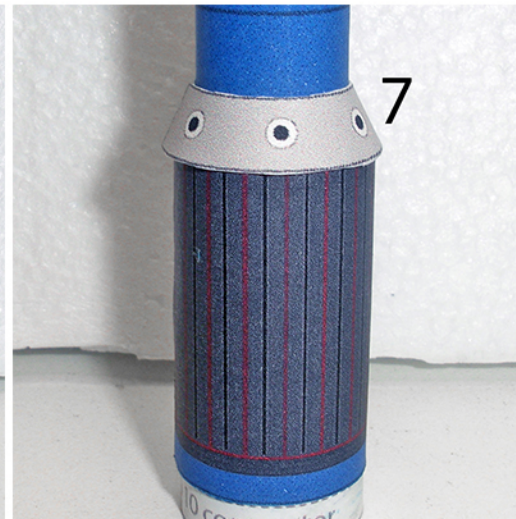

Slide 7 onto 8 and glue in place as shown.

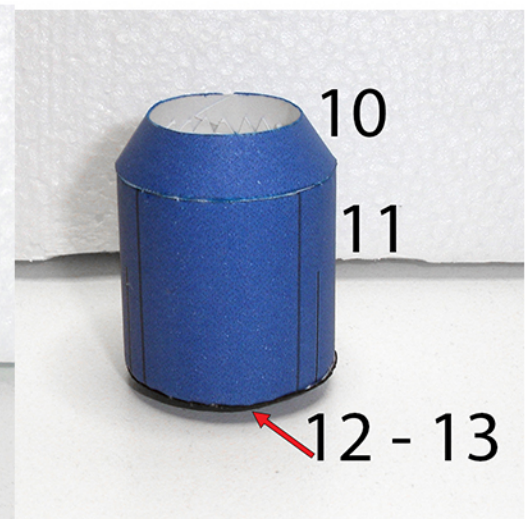

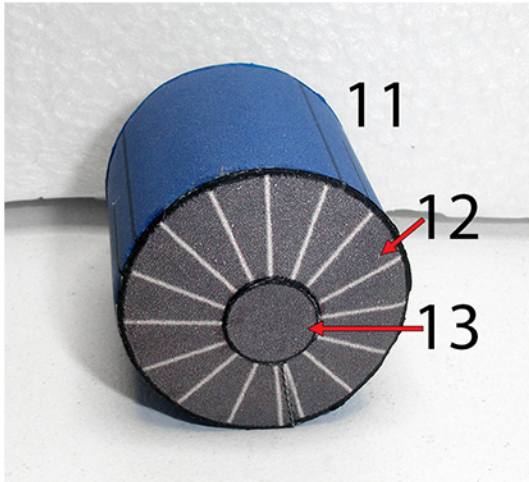

Glue to the bottom of 11

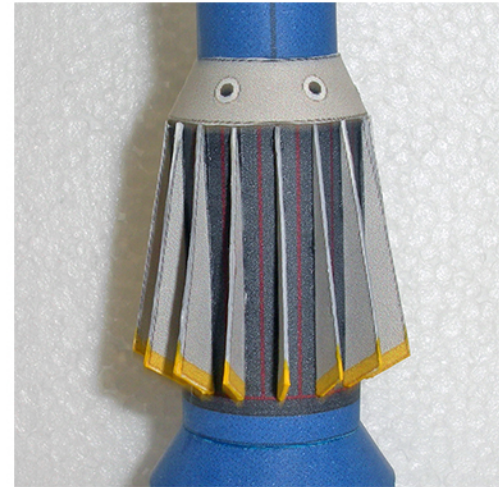
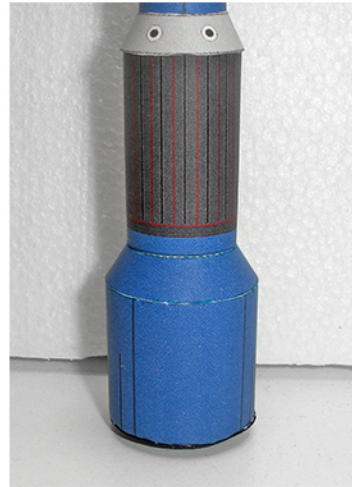

Glue Parts 15 onto the Black Lines as shown

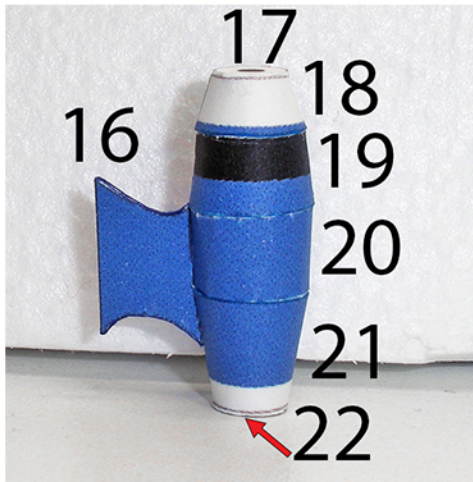

Glue 16 onto the Black lines at the seams

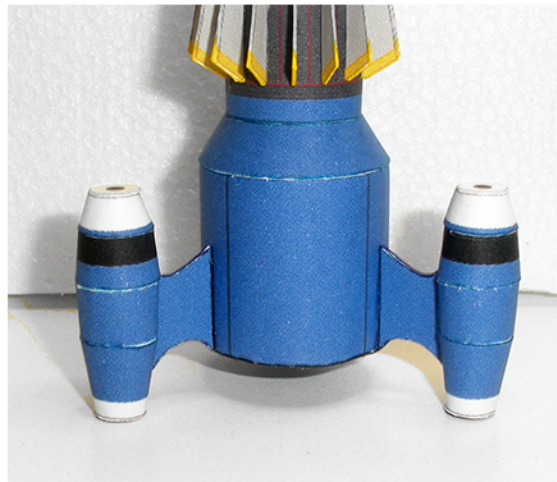

Glue the boosters onto the three (3) shorter black lines at the bottom of the body as shown, one of the black lines is at the seem at the backside.



Glue bottom of Parts 23 onto the small black circle on top of each booster as shown.

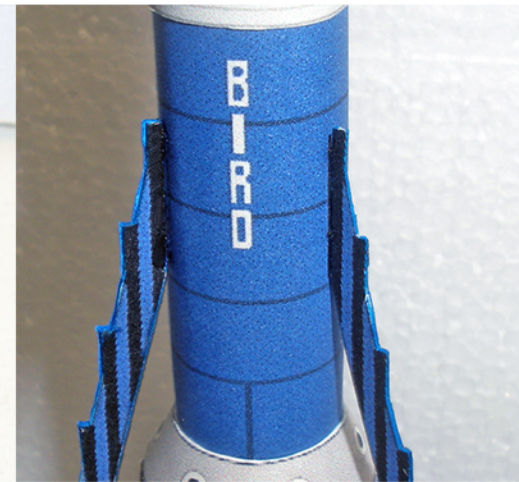

Glue the top of Parts 23 onto the three (3) shorter black lines as shown. One of the black lines is at the seem at the backside.

Your model is done.

Retro Rocket Ship 59

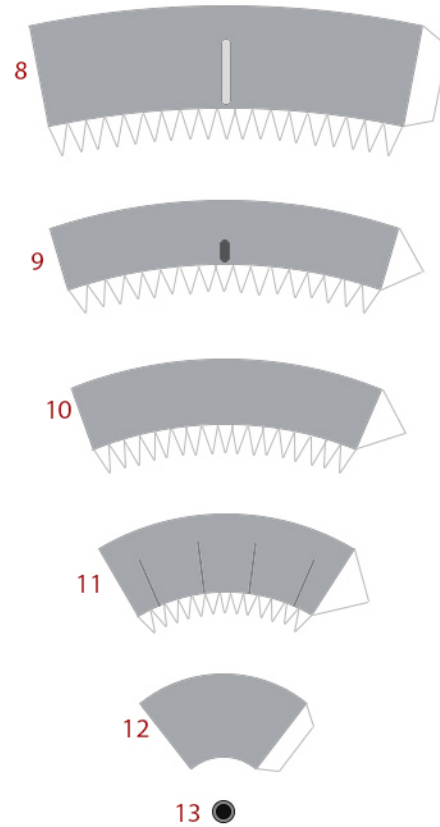
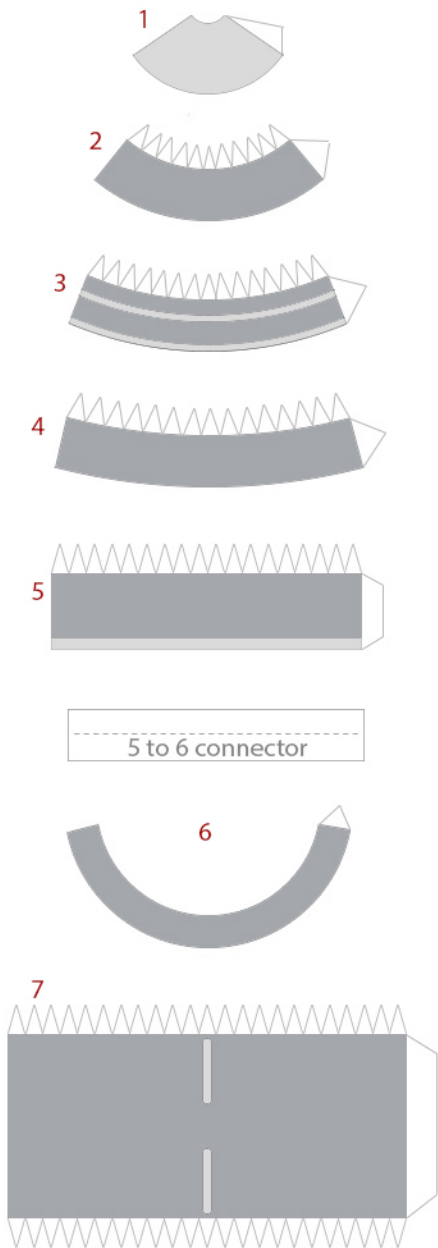

Cut a plastic broom straw or similar material the same length as the line above for the antenna

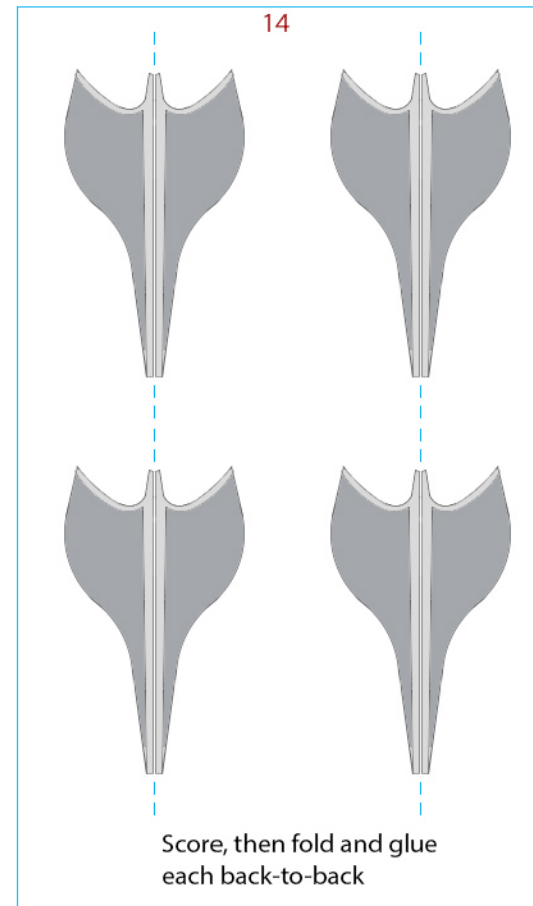

Retro Rocket Ship 59

Instructions

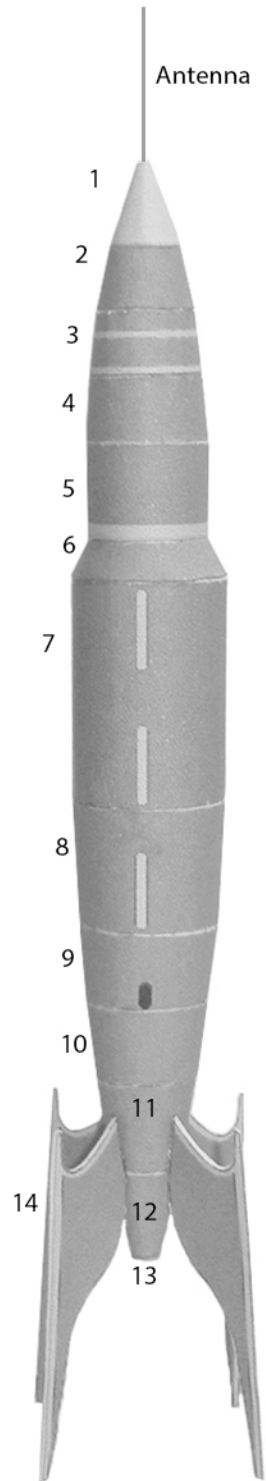

Keep all seems together

Use the 5 to 6 connector to glue 5 and 6 together.

Fins (Parts 14) are glued onto the black lines on 11

Insert the antenna onto the hole at the top.



Retro Rocket Ship 60

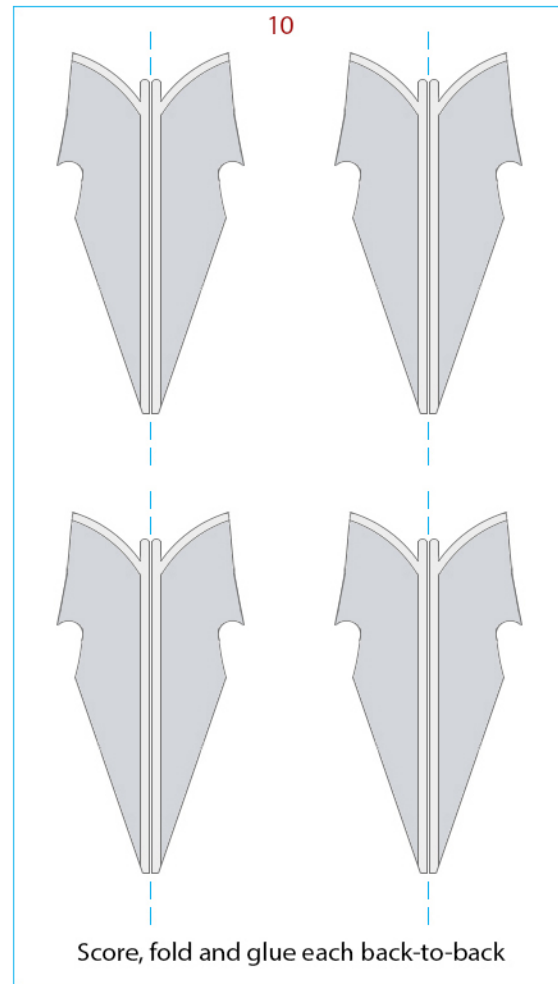
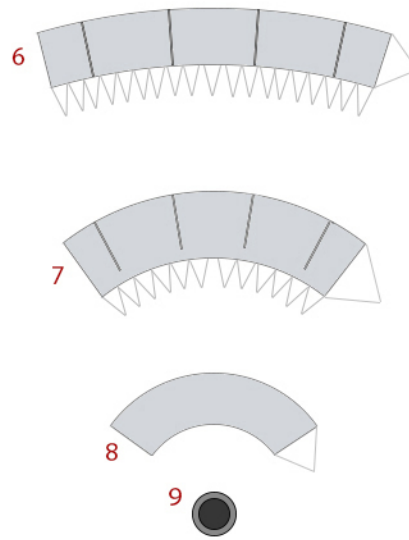
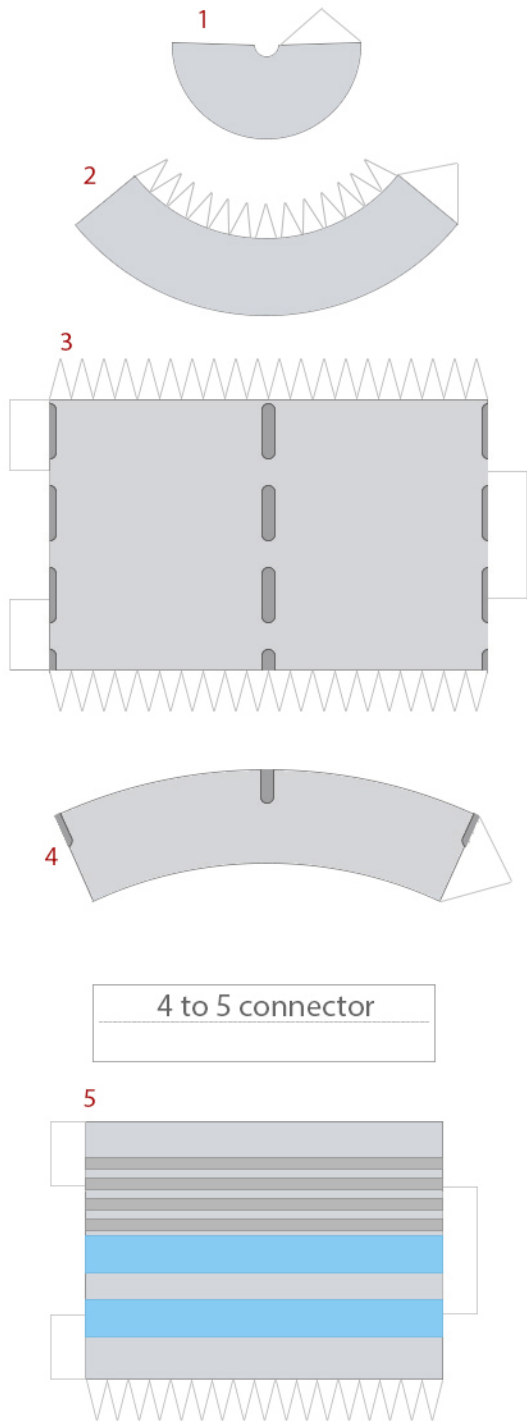

Instructions



Keep all seems together

Glue 4 and 5 together using the 4 to 5 connector

Glue Part 9 to the bottom

Glue fins (Parts 10) onto the black lines near the bottom as shown