

Retro Rocket Ship 25

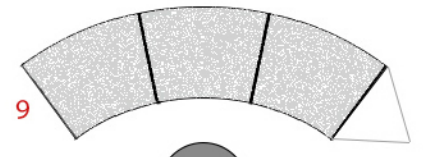

10
Glue to cardstock

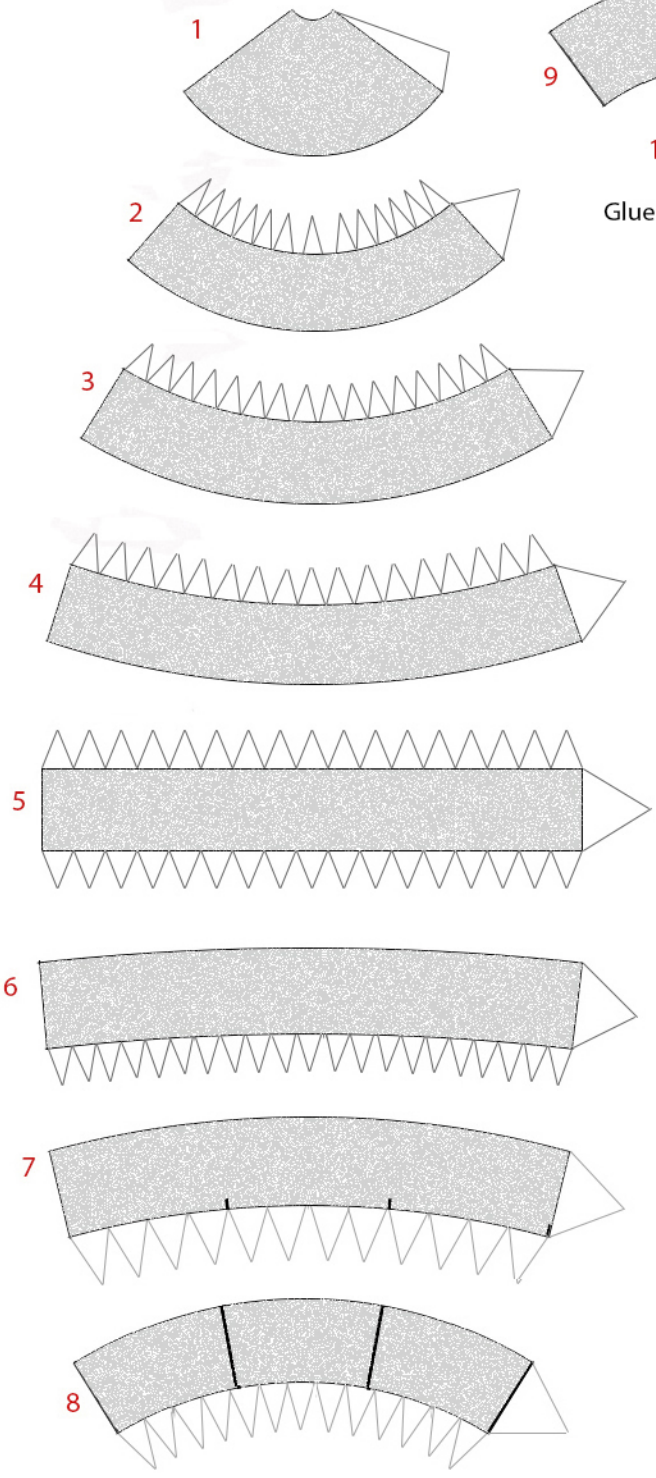
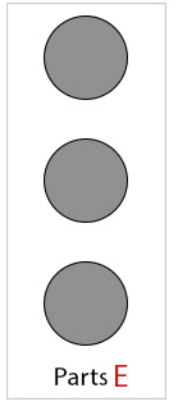
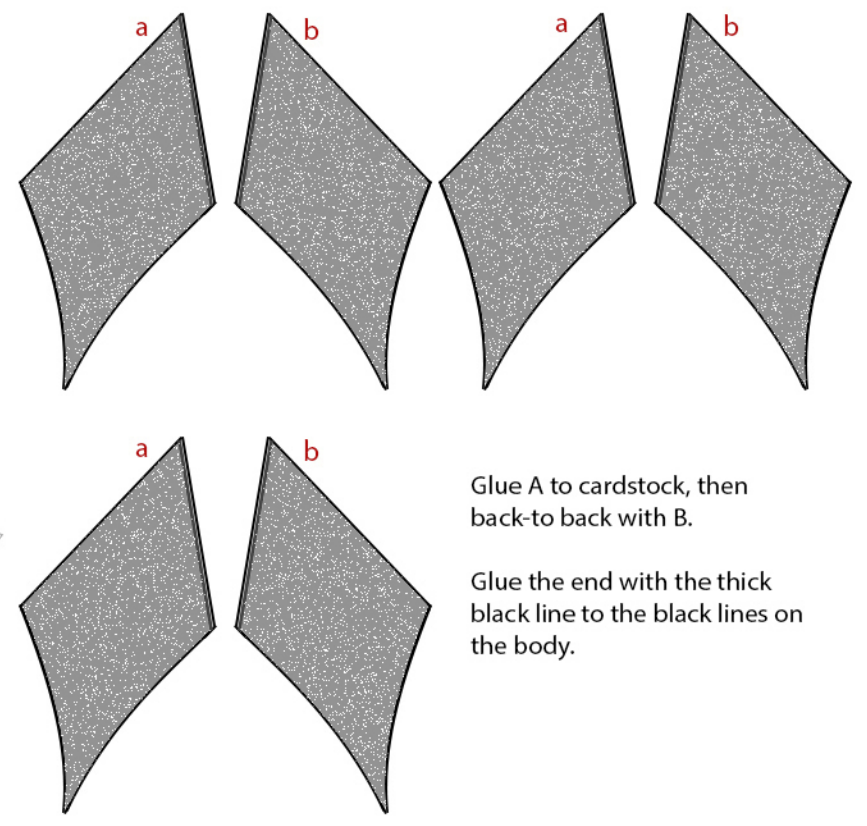
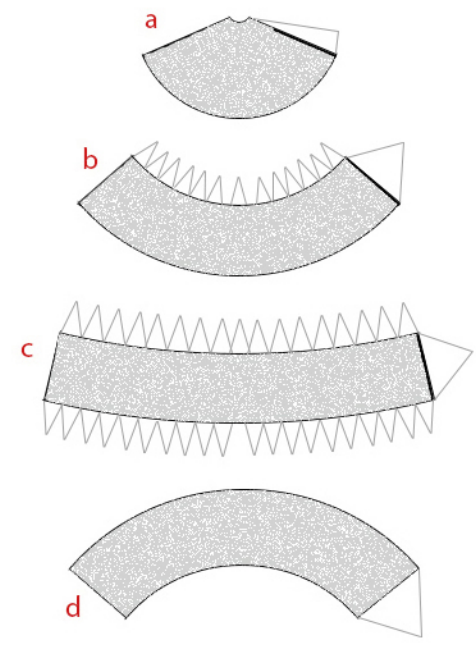
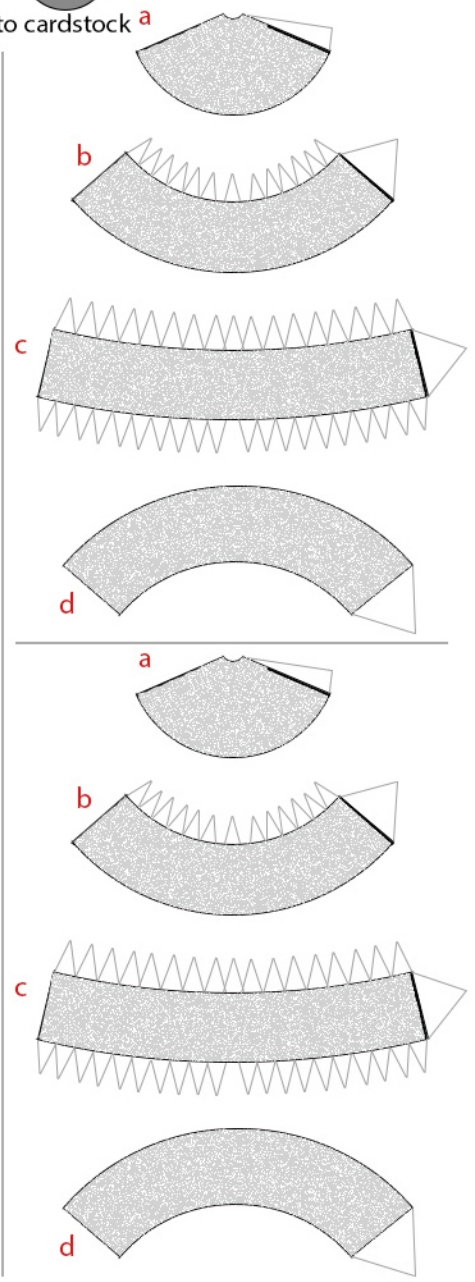

Glue A to cardstock, then back-to-back with B.

Glue the end with the thick black line to the black lines on the body.

Instructions

Keep all seems aligned

Glue the edge with the thick dark line on the fins onto the black lines on the body.

Glue the other edge of the fins onto the black lines on parts a-d as shown.

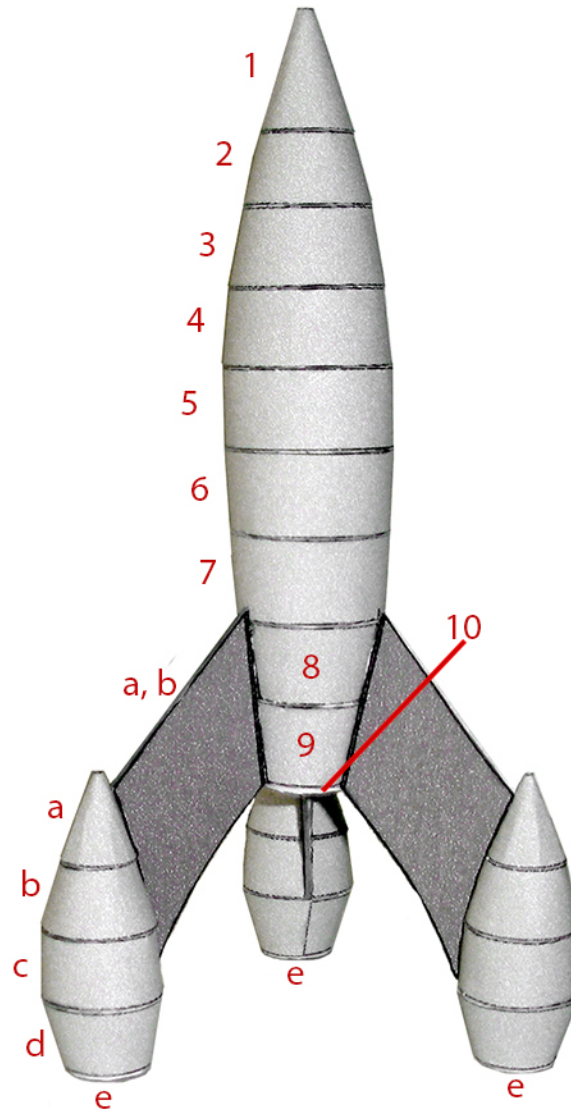

Retro Rocket Ship 26

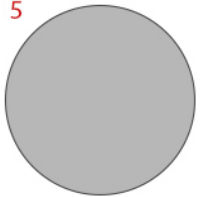
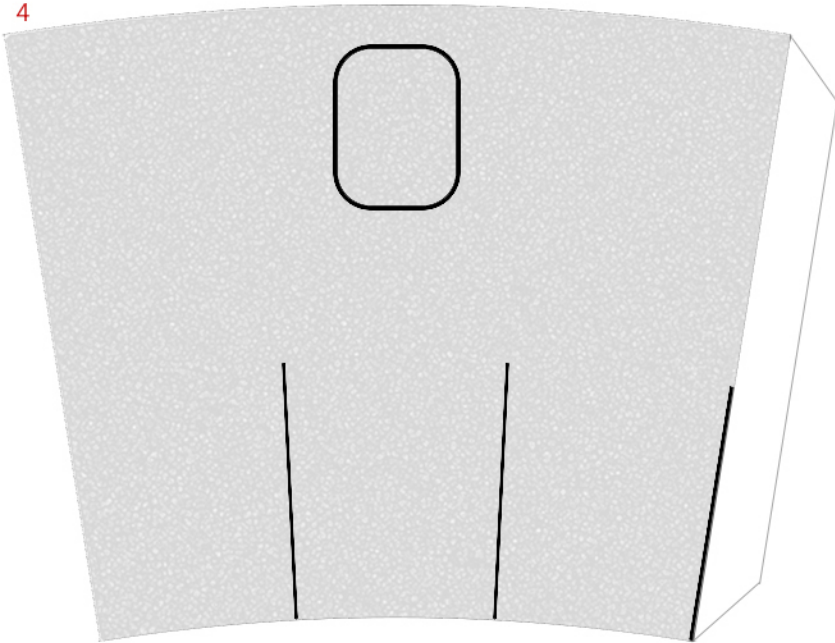
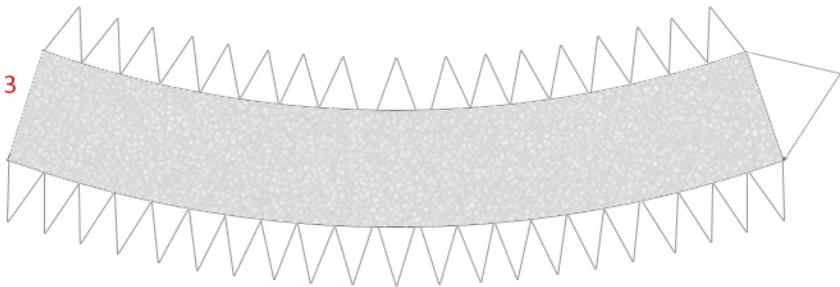
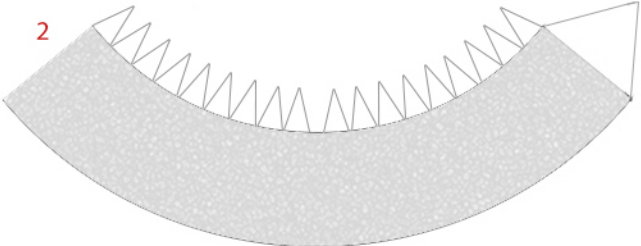
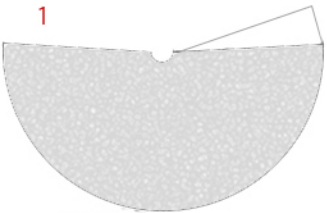

Glue to Cardstock

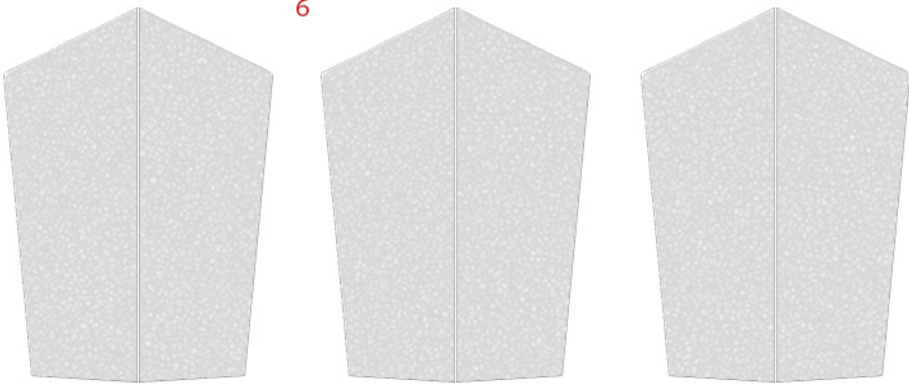

Fold each fin back-to-back

Instructions

Keep all seems aligned

Glue the fins onto the three black lines
on the body as shown.

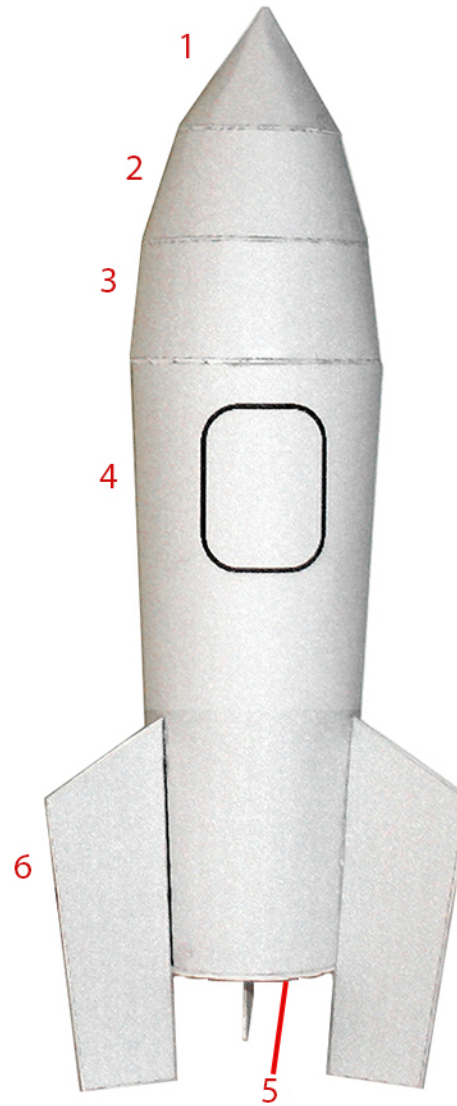

Retro Rocket Ship 27

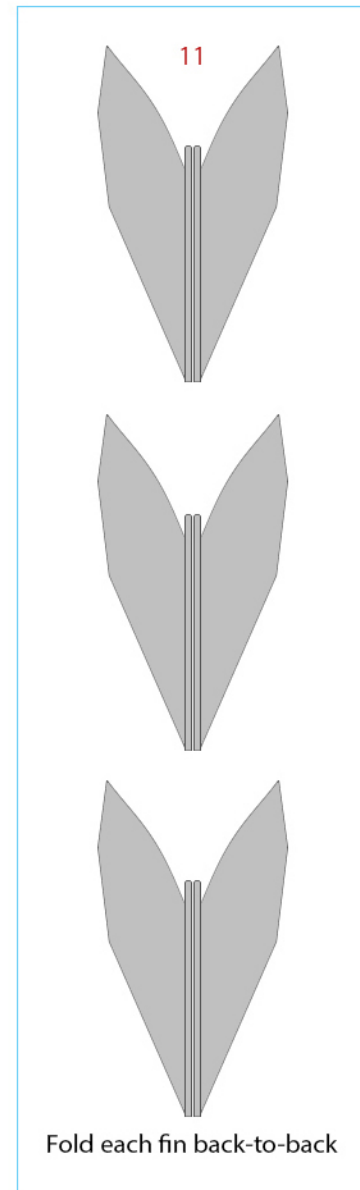
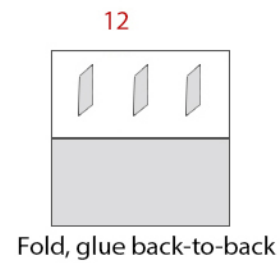
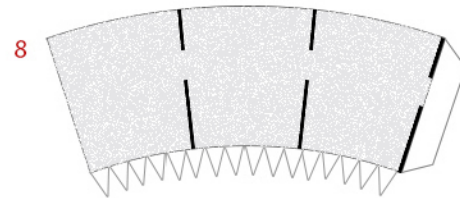
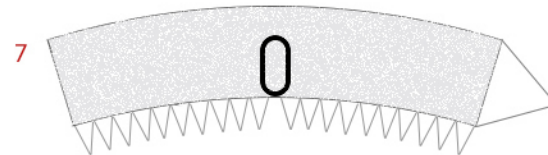
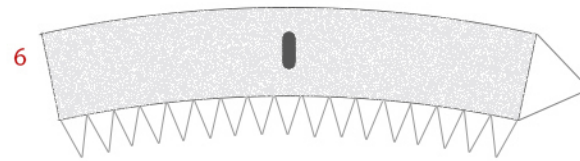
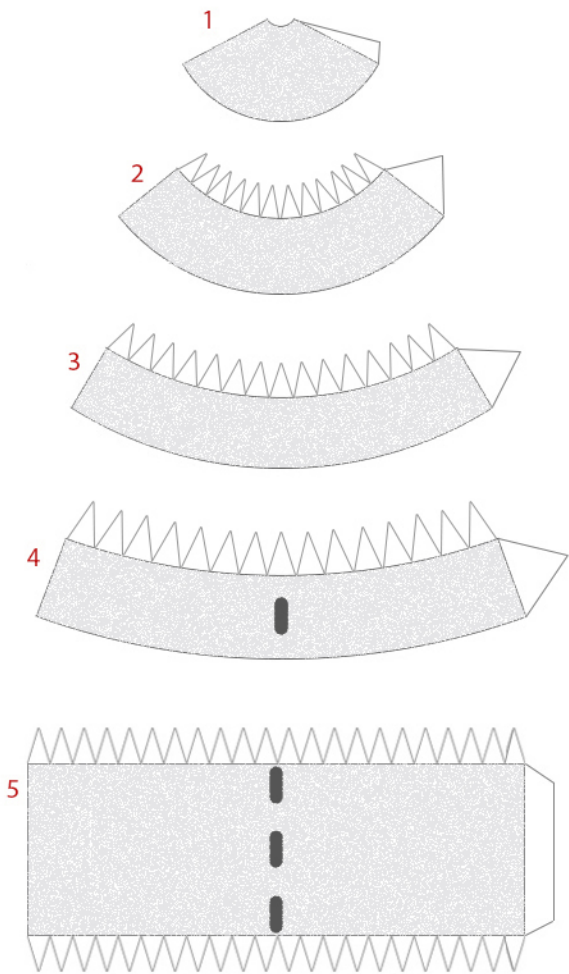

Instructions

Keep all seems aligned

Glue 12 on the short black lines on part 8

Glue 11 on the long black lines on part 8

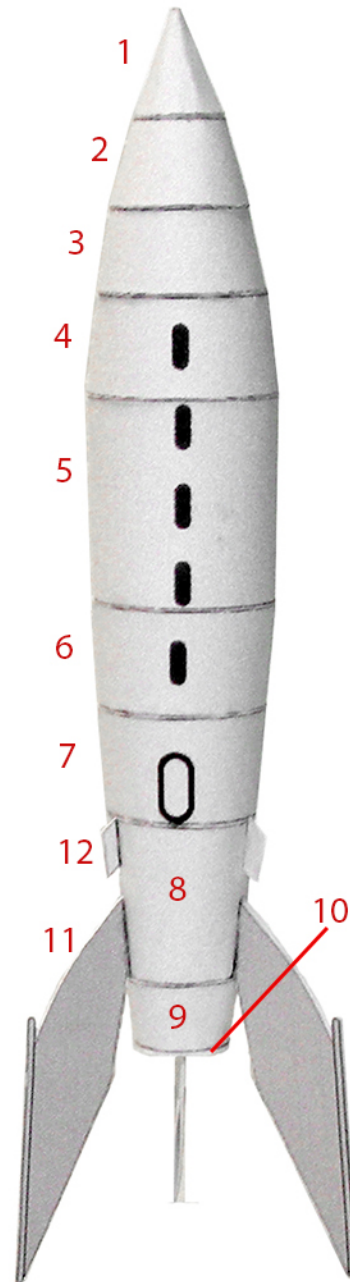

Retro Rocket Ship 28

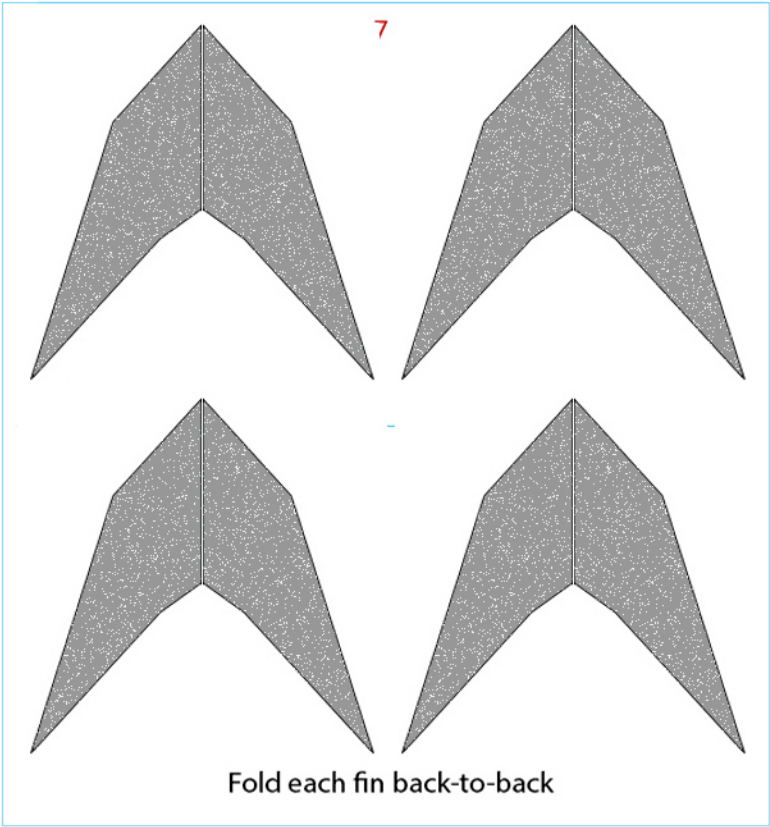
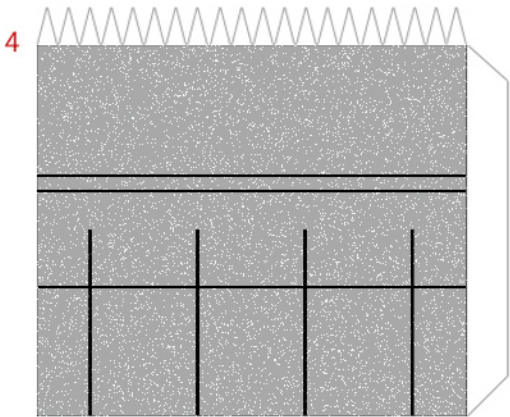
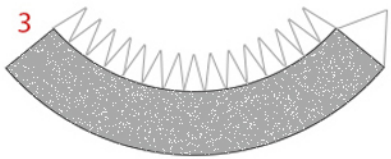
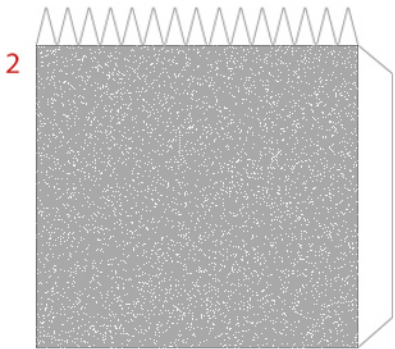
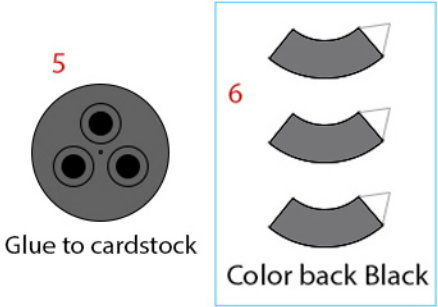
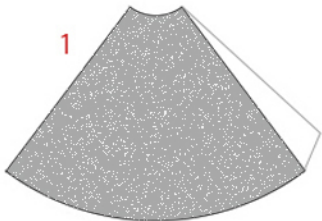

Instructions

Keep all seems aligned

Glue the fins (parts 7) to the four black lines on the body.



Retro Rocket Ship 29

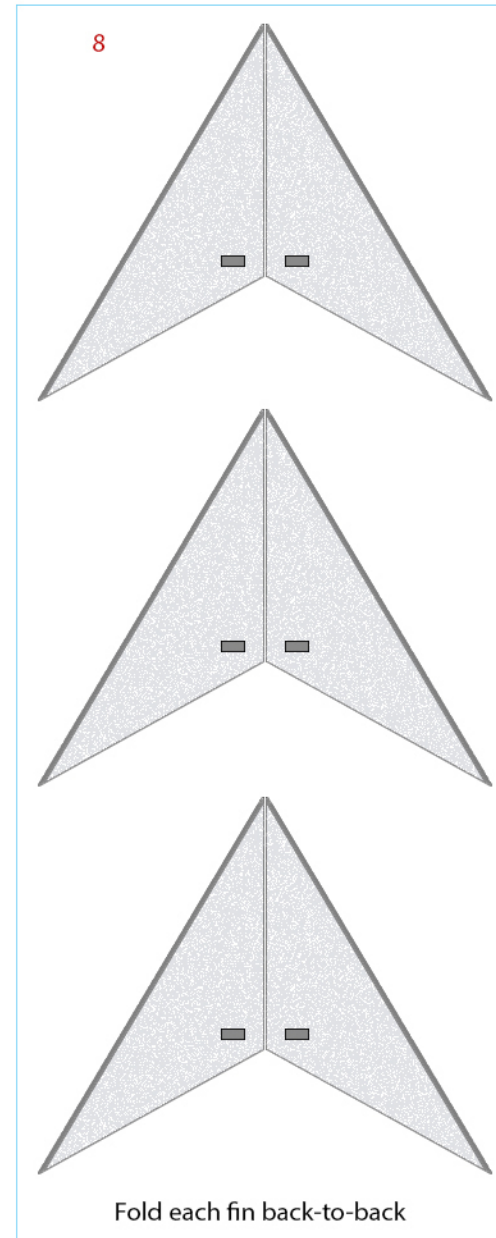
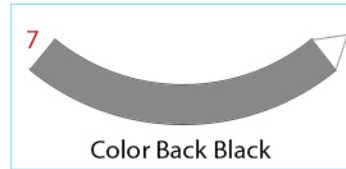
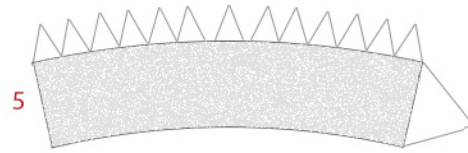
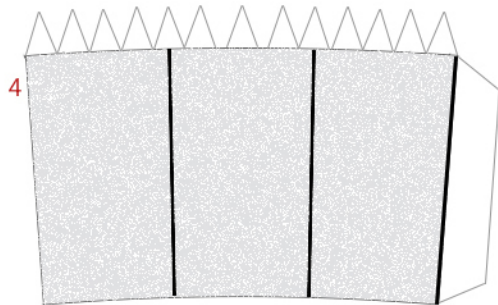
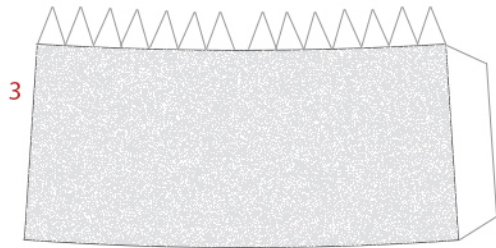
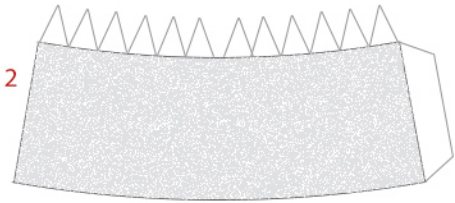
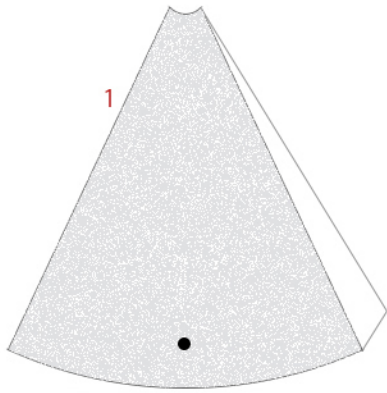

Instructions



Keep all seems aligned

Glue the fins (parts 8) onto the black lines on part 4 as shown

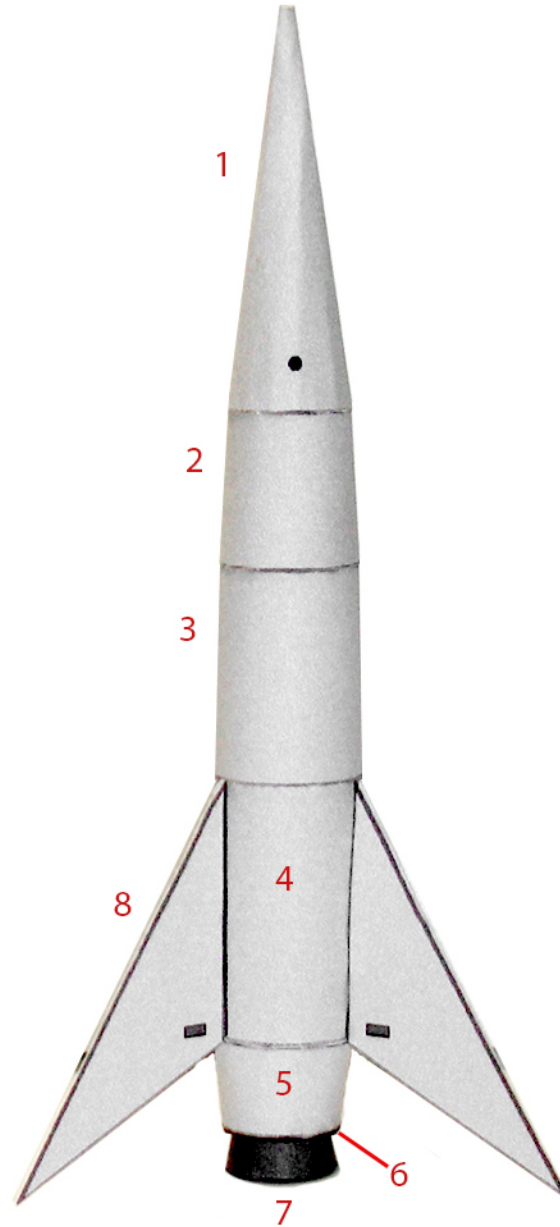

Retro Rocket Ship 30

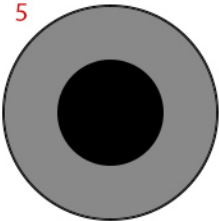
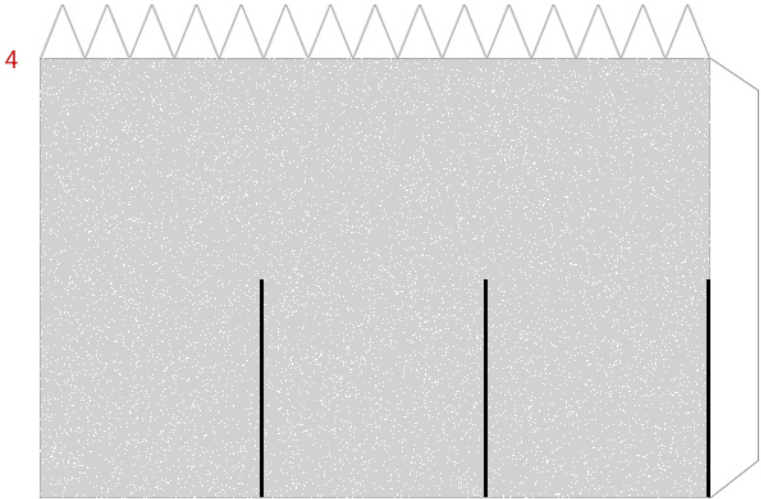
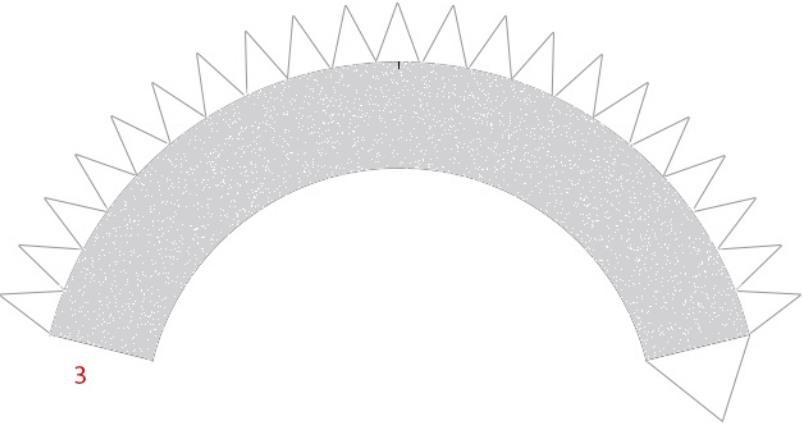
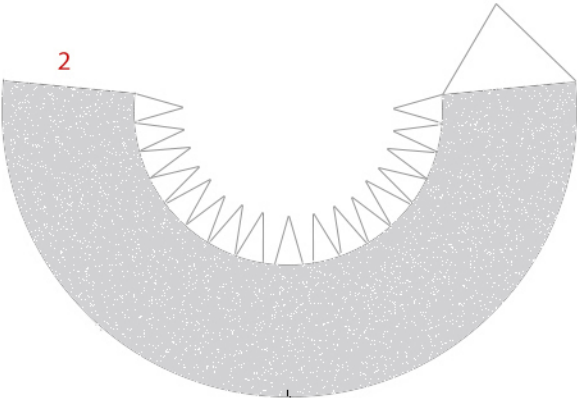

Glue to cardstock

6

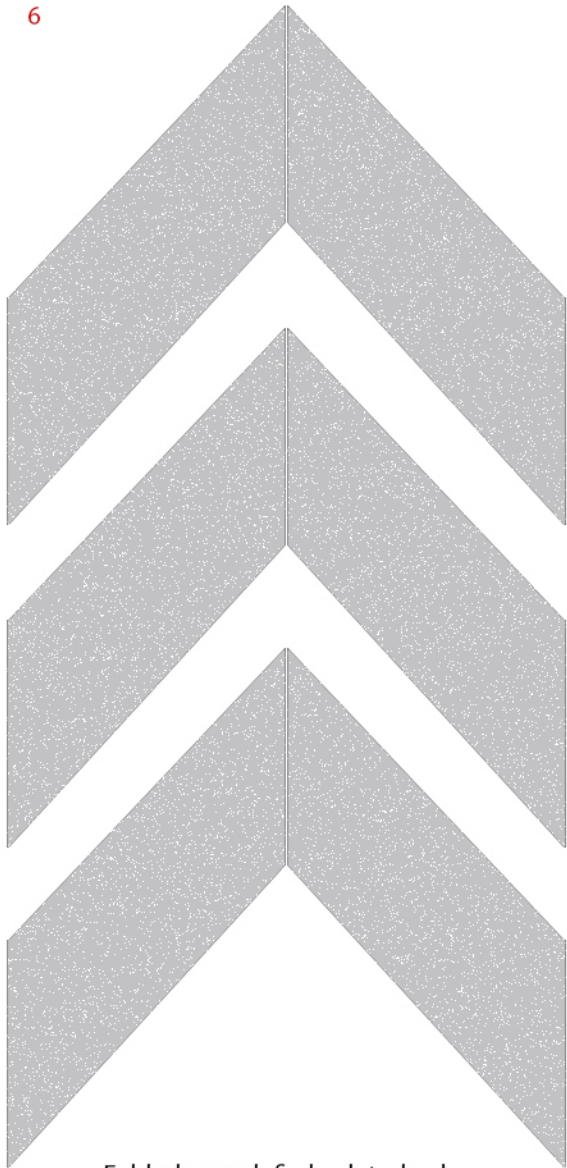

Fold-glue each fin back-to-back

Instructions

Keep all seems aligned

Match the two markers on parts 2 and 3.

Glue the fins (parts 6) onto the black lines on the body as shown

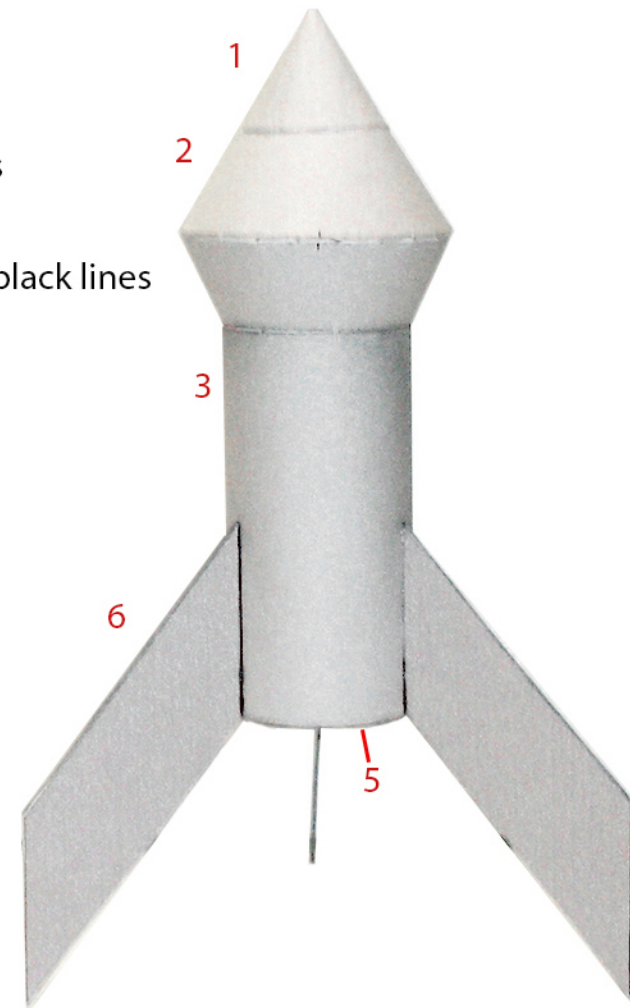

Retro Rocket Ship 31

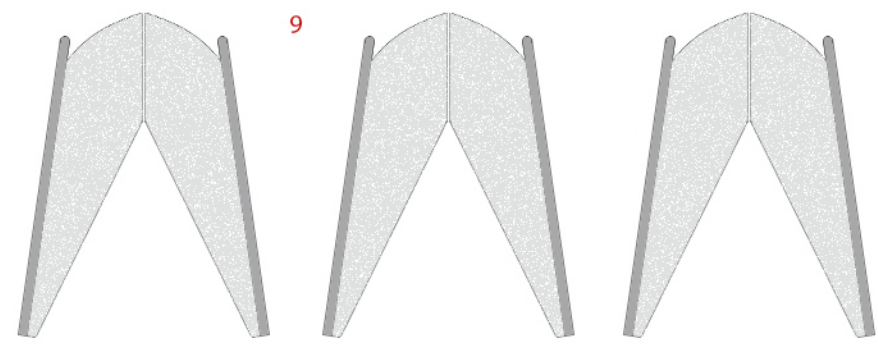
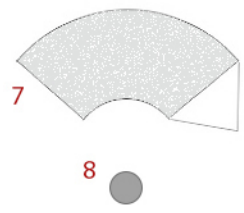
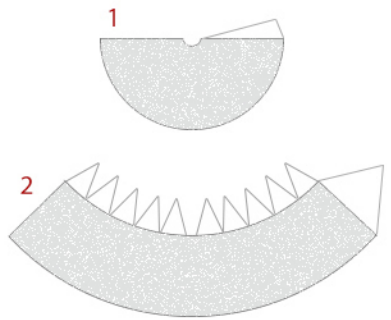

Fold, glue as fin back-to-back

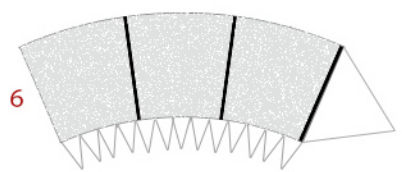
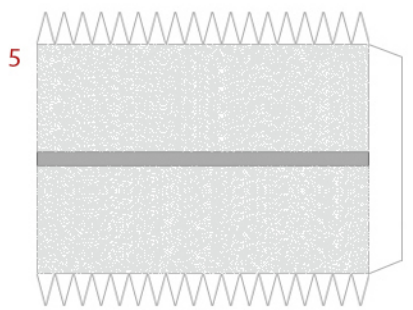
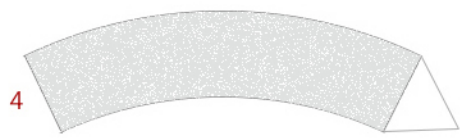
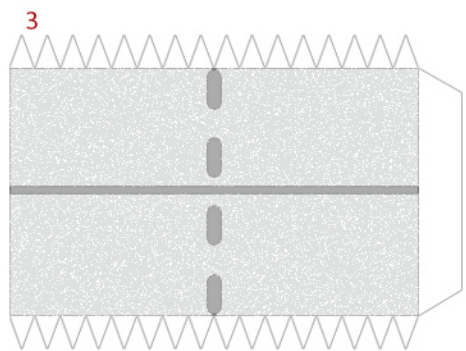

Instructions

Keep all seems aligned

Glue the fins (Parts 9) to the black lines on part 6 as shown.

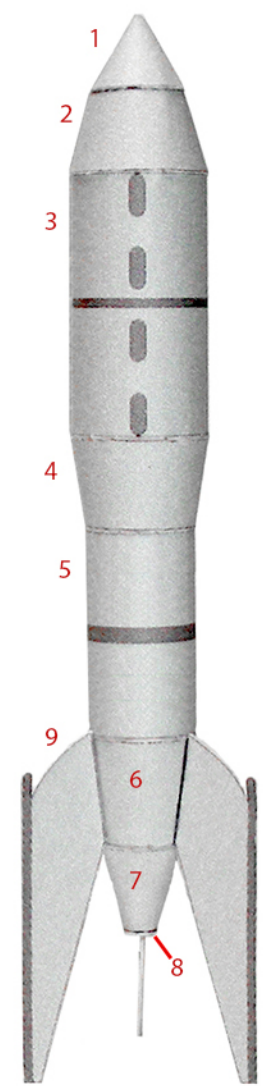

Retro Rocket Ship 32

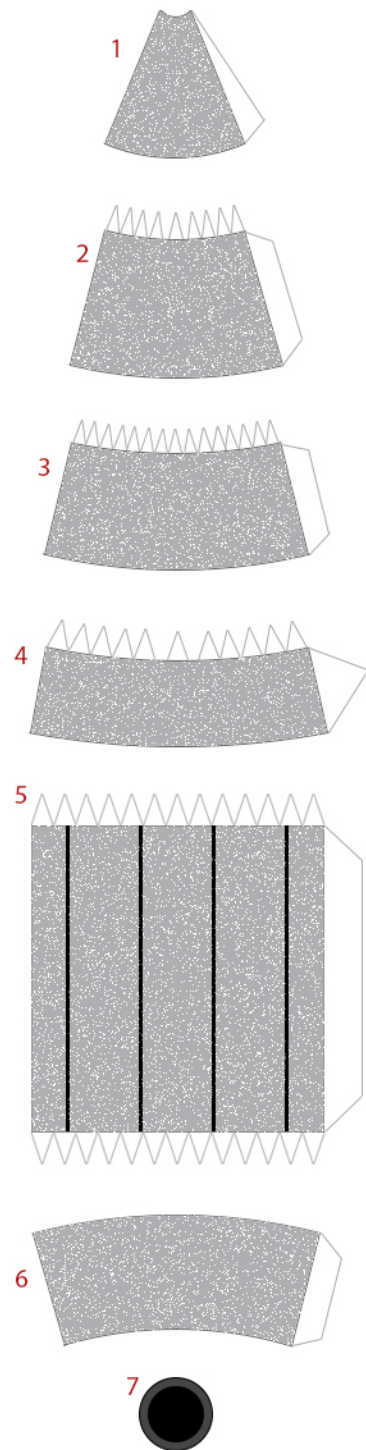

8 
Color back Black

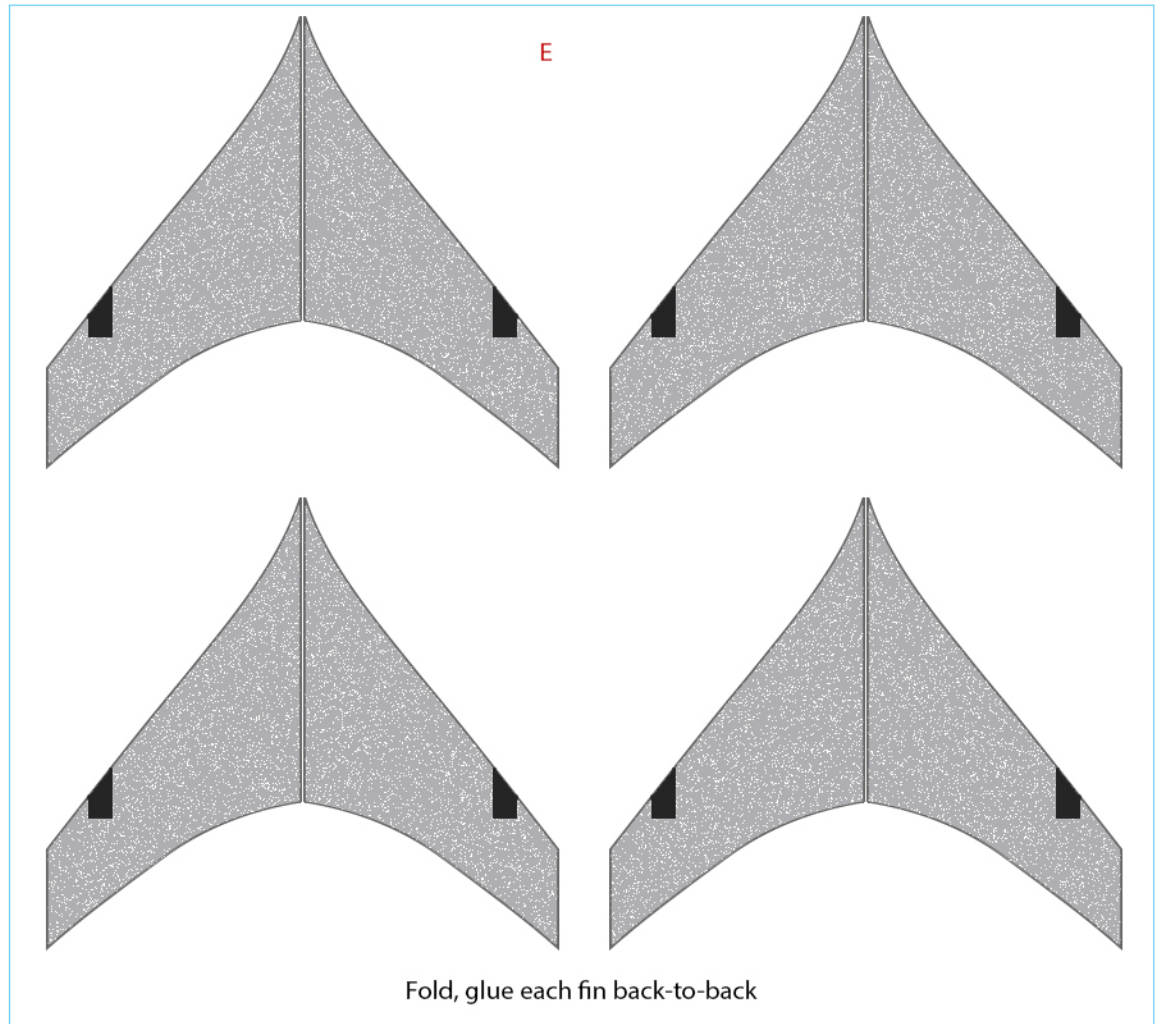
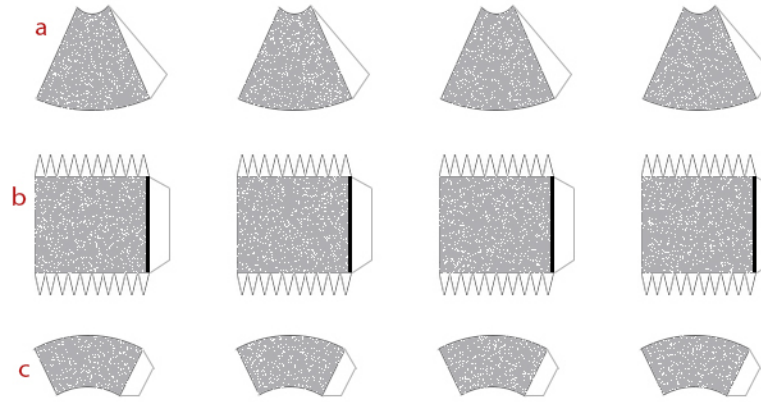

Retro Rocket Ship 32

Instructions

Keep all seems aligned

Glue the fins (Parts E) to the black lines as shown

Glue the other end of the fins onto the black line on Parts b as shown.

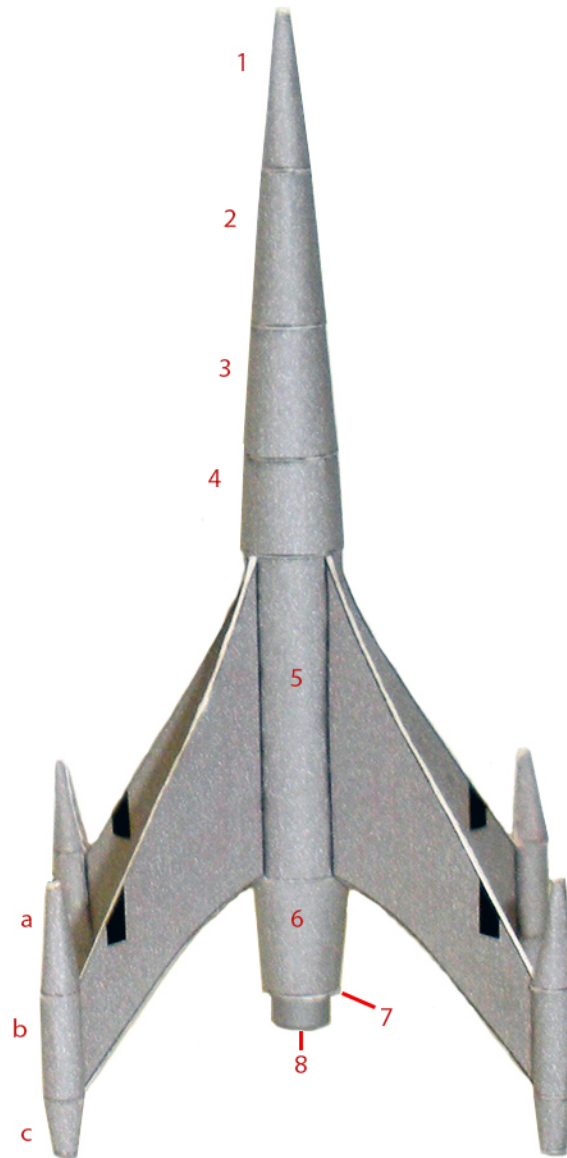

Retro Rocket Ship 33

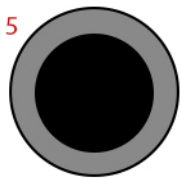
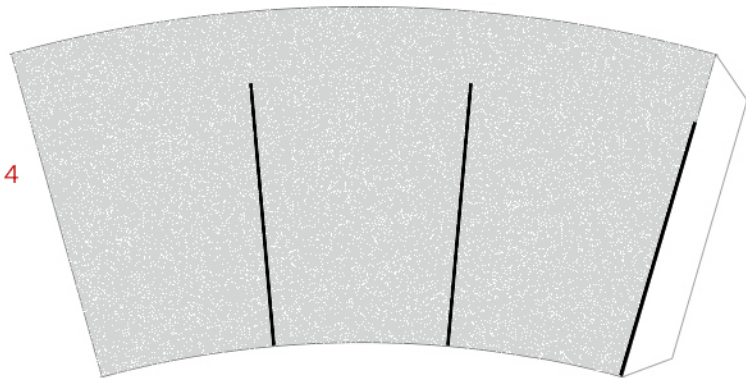
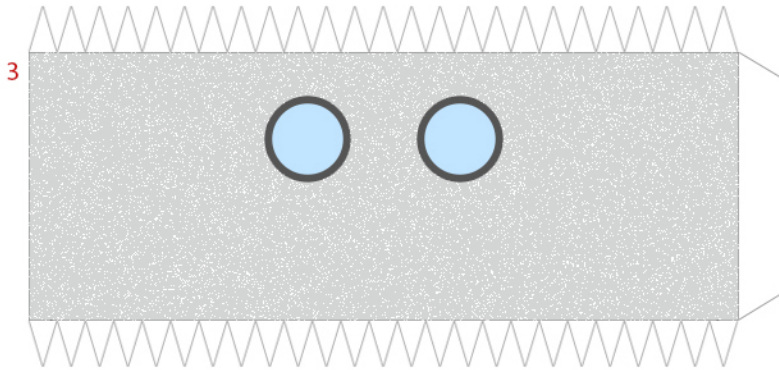
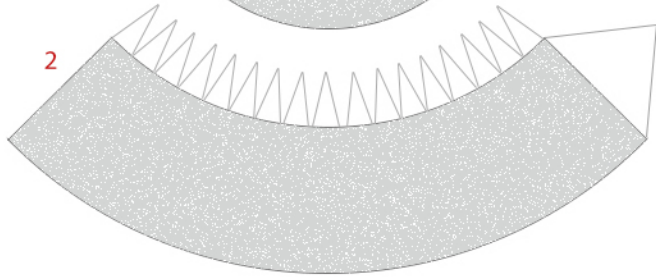
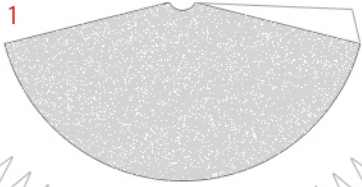

Glue to cardstock

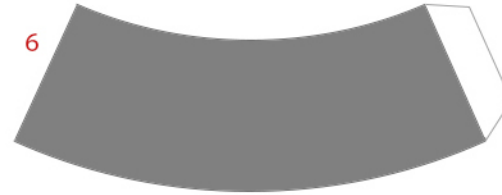

Color back Black

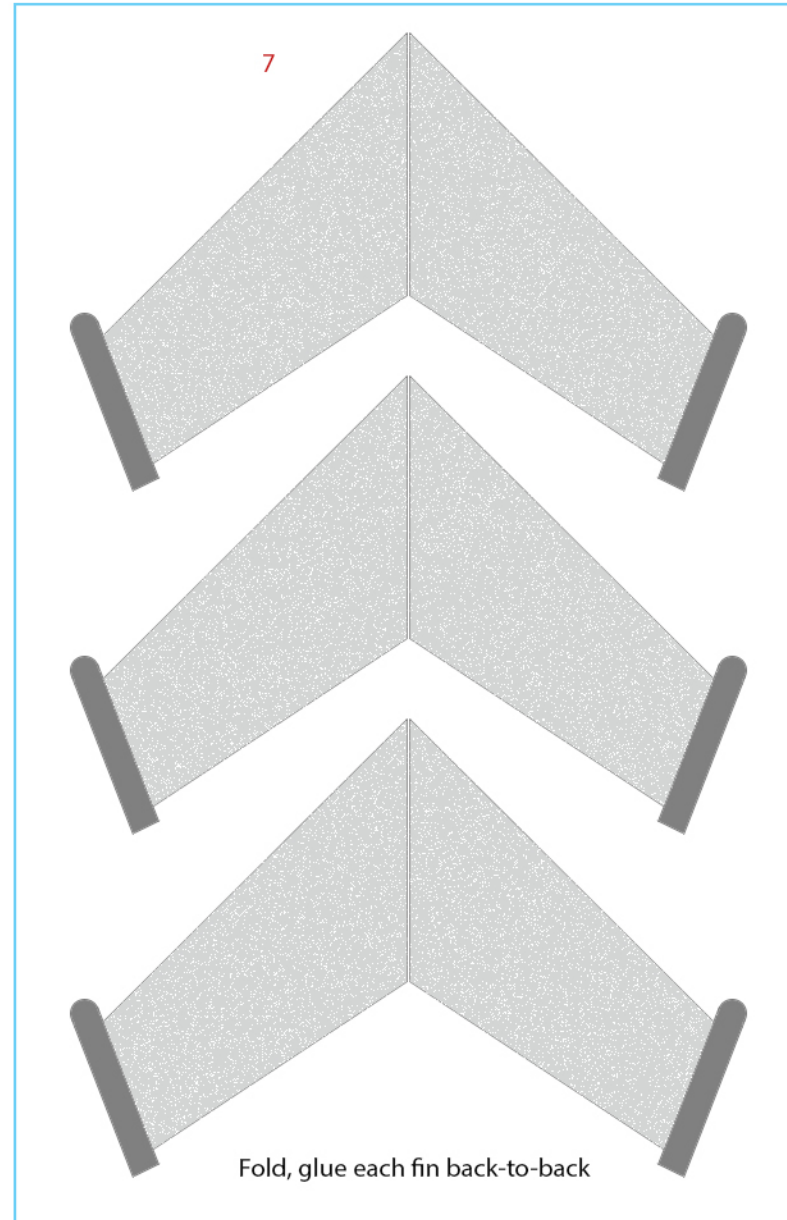



Instructions

Keep all seems aligned

Glue the fins on the black lines as shown

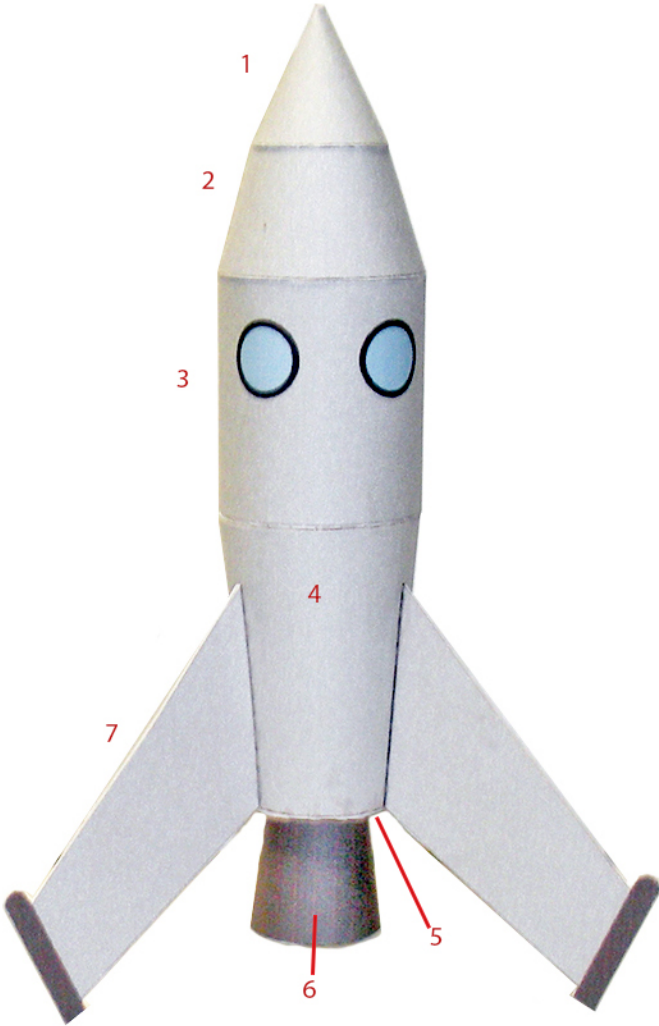

Retro Rocket Ship 34

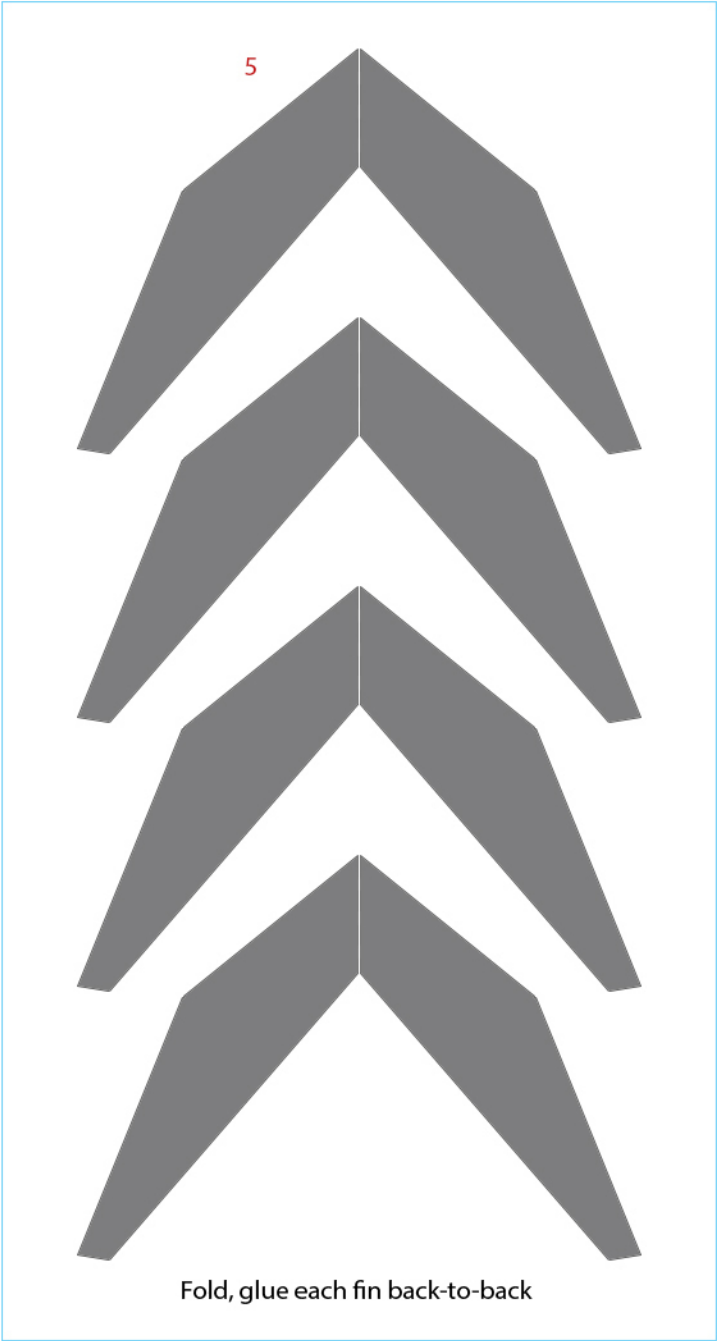
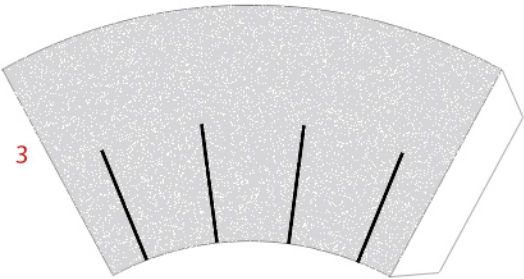
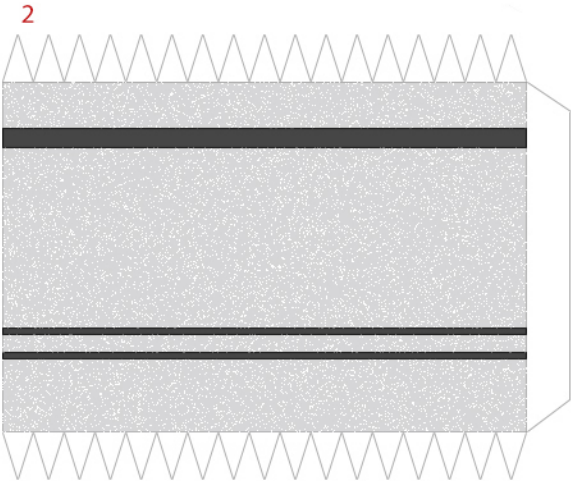

Instructions

Keep all seems aligned

Glue the fins on the black lines as shown

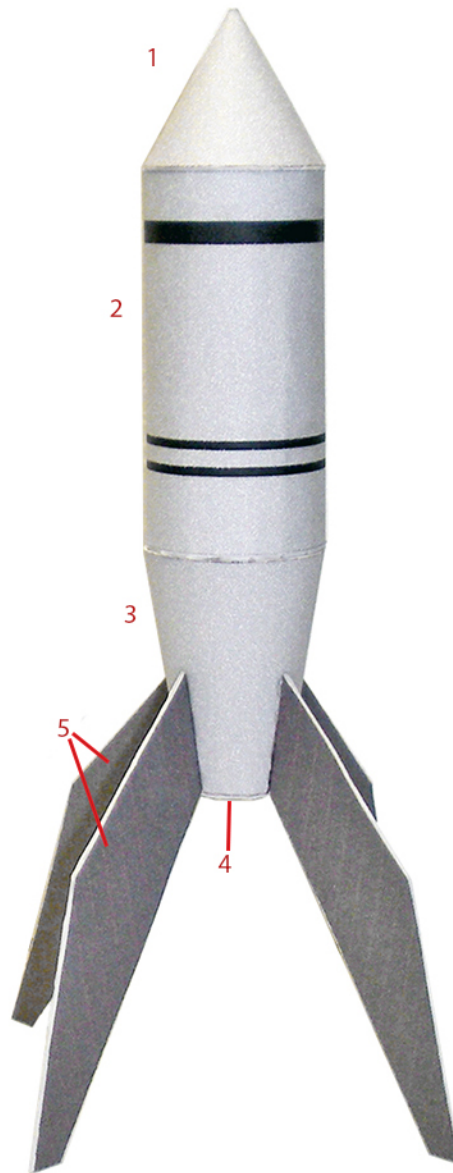

Retro Rocket Ship 35



Instructions

Keep all seems aligned

Glue the fins on the black lines on part 5 as shown.

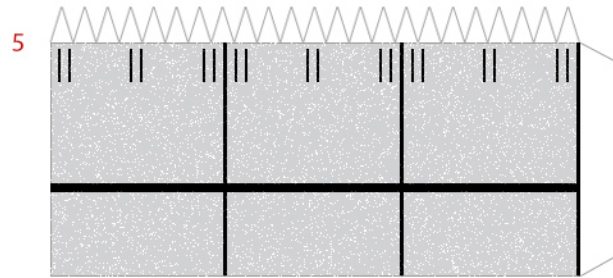
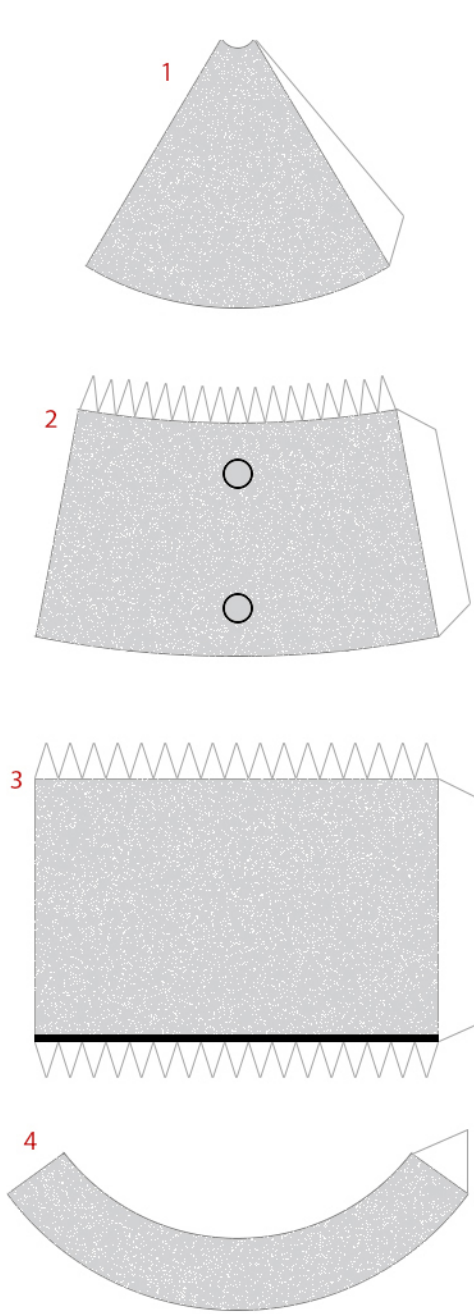

Glue to cardstock

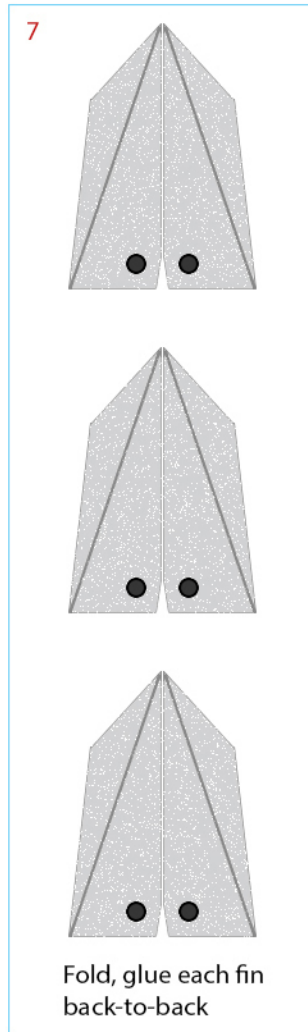

Fold, glue each fin back-to-back



Retro Rocket Ship 36

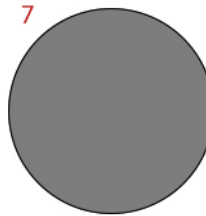
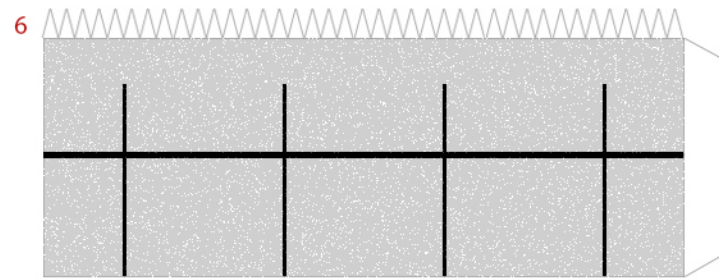
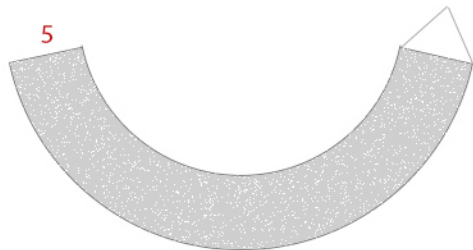
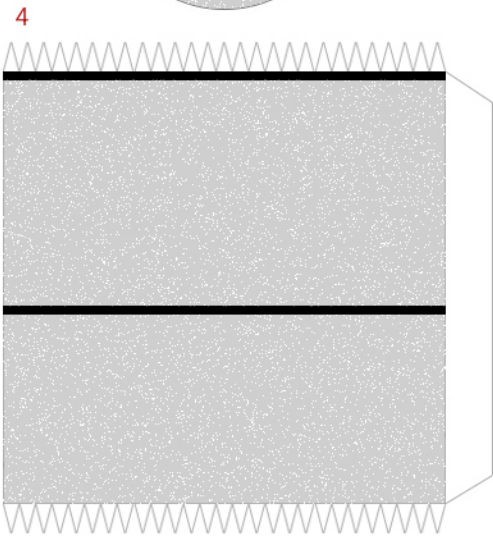
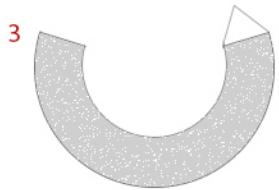
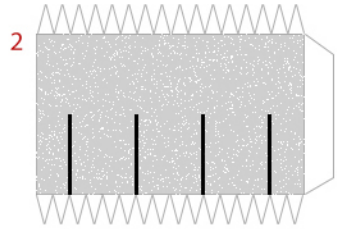

Glue to cardstock

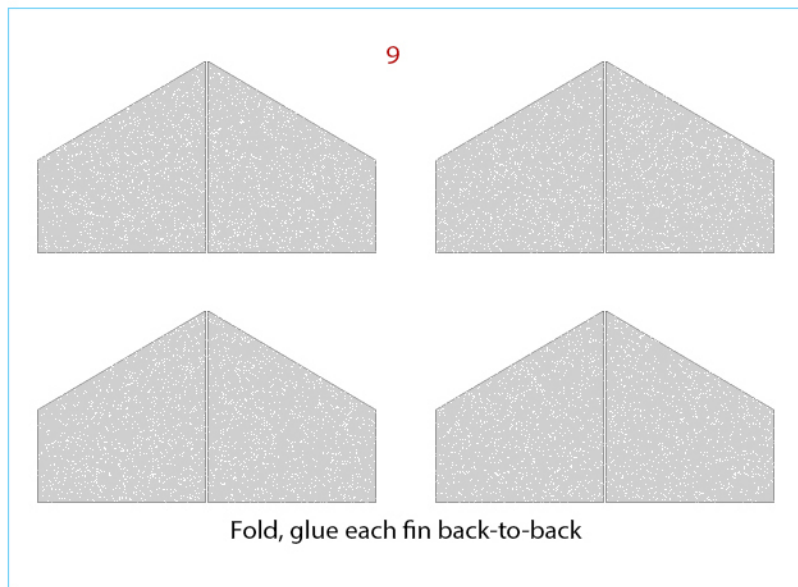
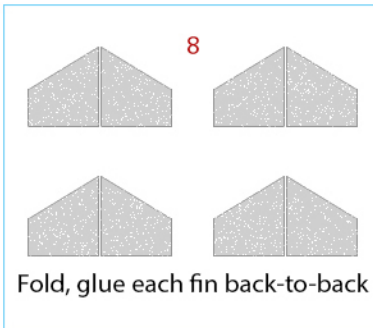

Instructions

Keep all seems aligned

Glue the small fins (Parts 8) onto the short black lines on Part 2

Glue the larger fins (Parts 9) onto the black lines on the bottom.

