

Retro Rocket ship 13

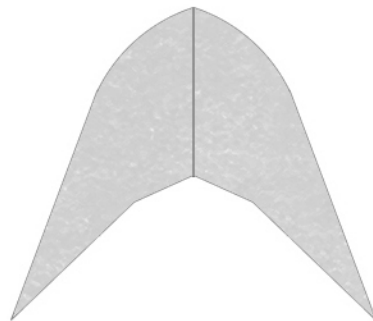
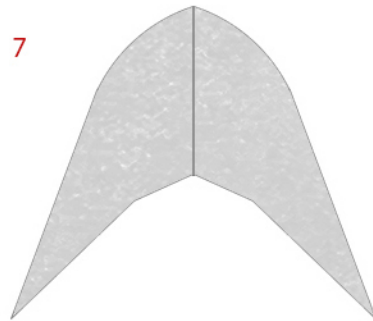
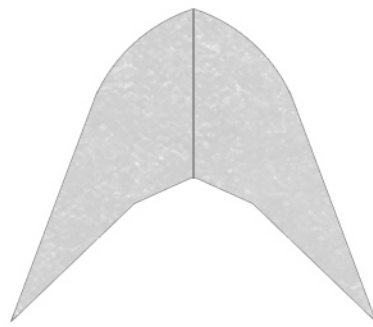
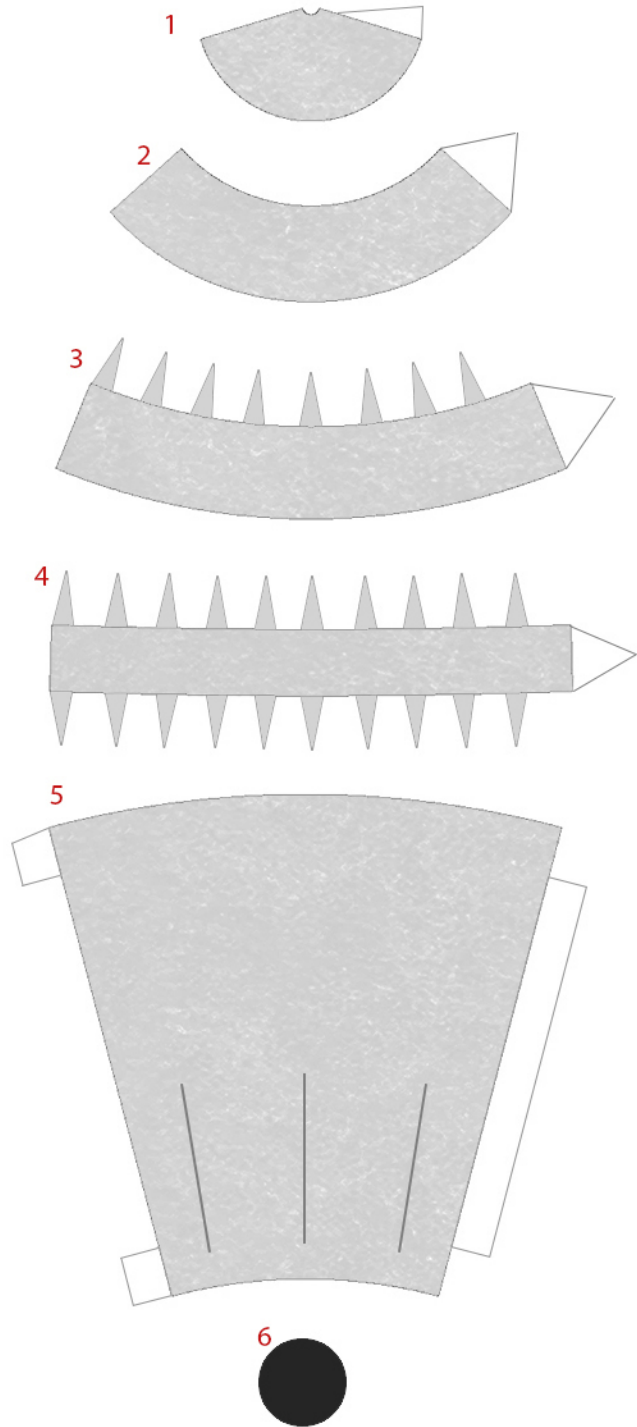

Fold -glue the fins in half back-to-back.

Instructions

Keep all seems aligned during assembly.

Glue 6 to the bottom as shown.

Glue the fins on the dark lines on part 5.

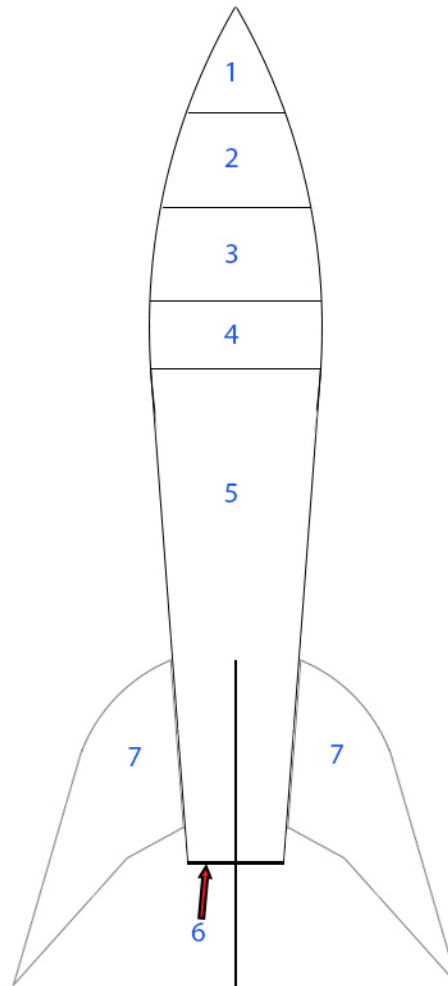

Retro Rocket ship 14

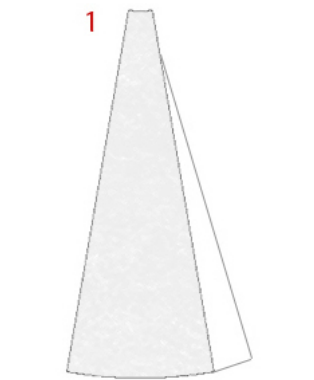

1



4



Glue each set
back-to-back

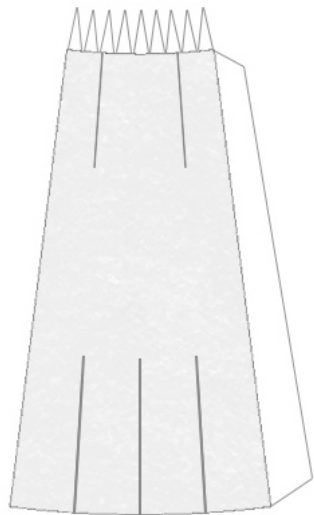

3



Fold-glue each fin in
half back-to-back.

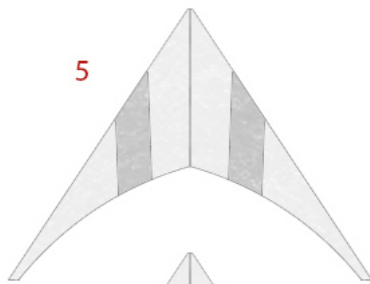

5

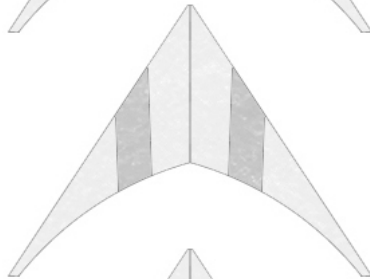
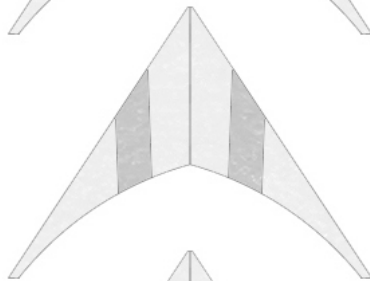

Instructions

Keep all seems aligned during assembly.

Glue 3 to the bottom as shown.

Glue parts 4 to the two lines on the top area of part 2.

Glue the fins (parts 5) to the three lines and the seem on the lower area on part 2.

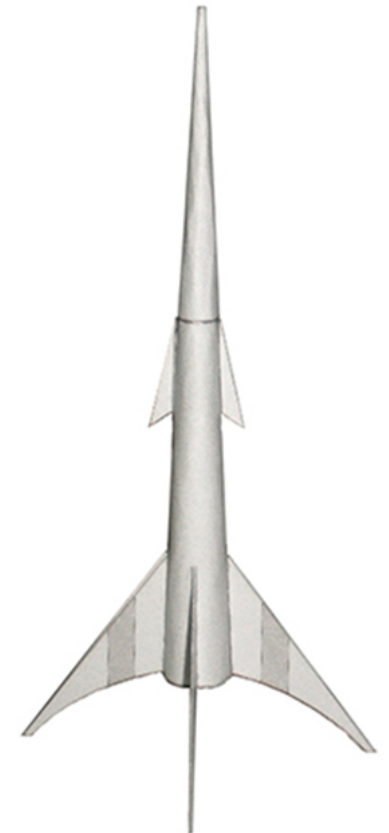
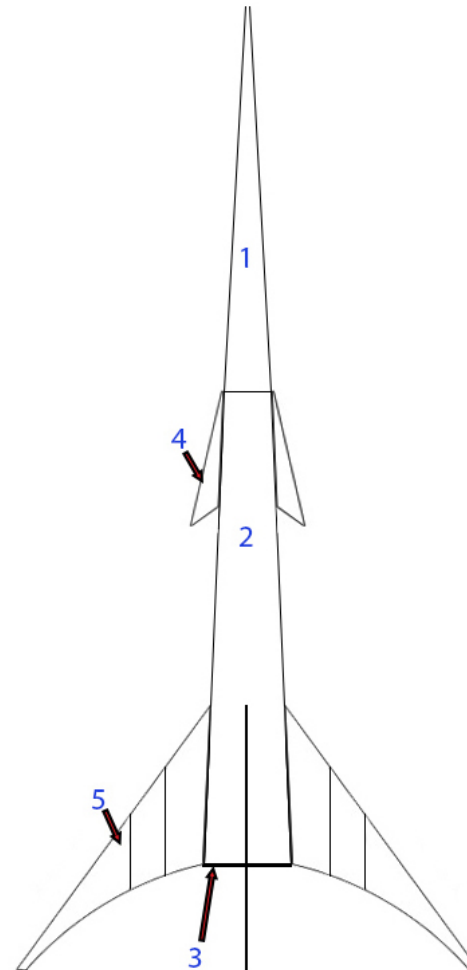

Completed Model

Retro Rocket ship 15

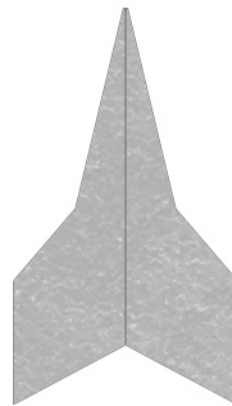
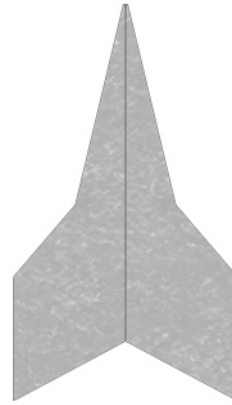
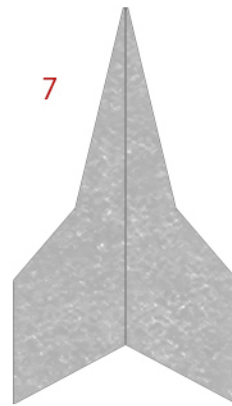
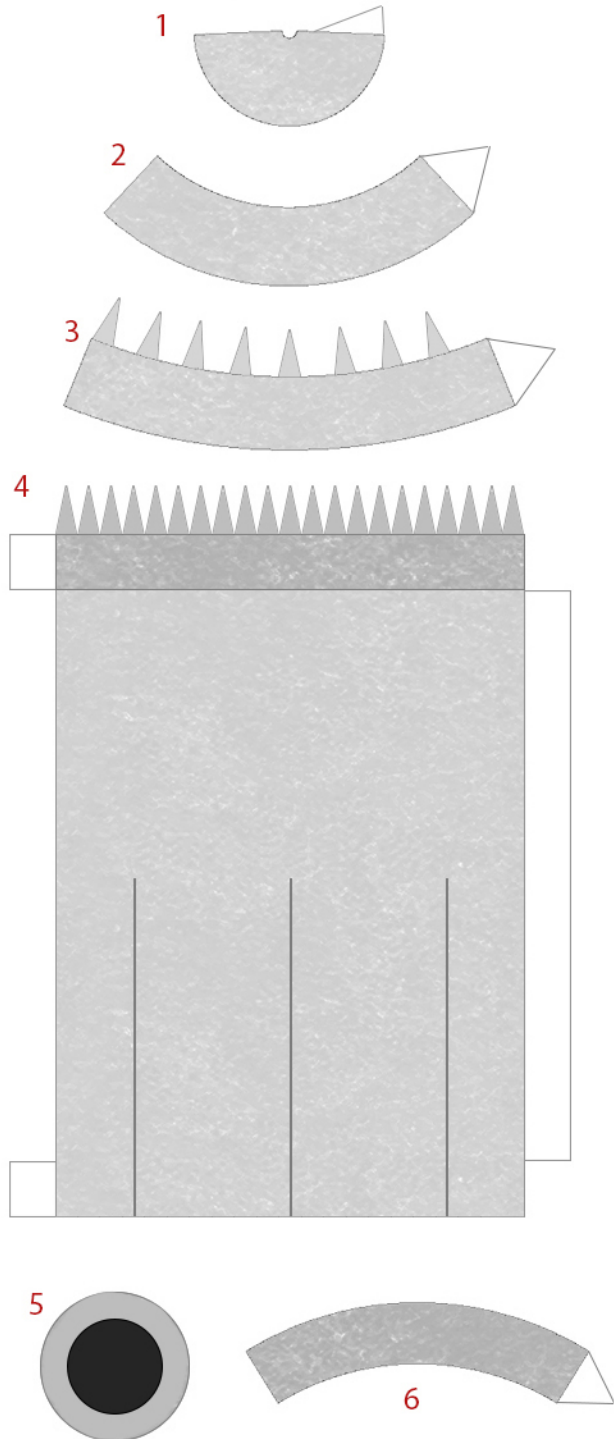

Fold-glue each fin in half back-to-back

Instructions

Keep all seems aligned during assembly.
Glue 5 to the bottom of the body.
Glue 6 onto 5.
Glue the fins onto the three lines as shown.

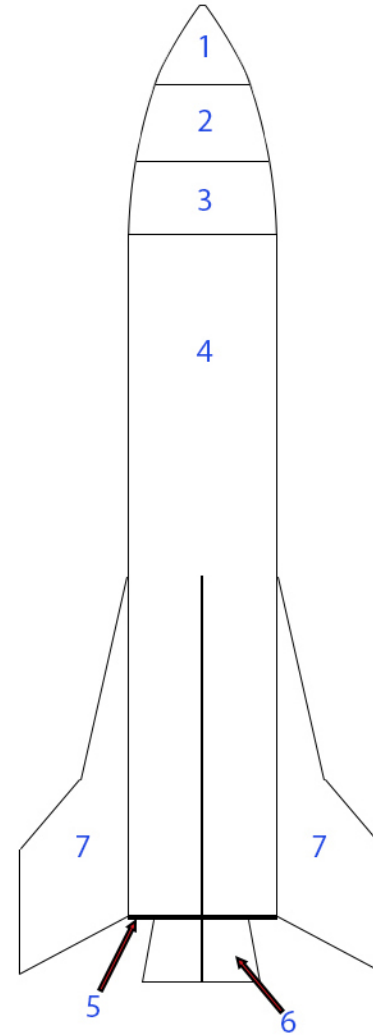

Completed Model

Retro Rocket ship 16

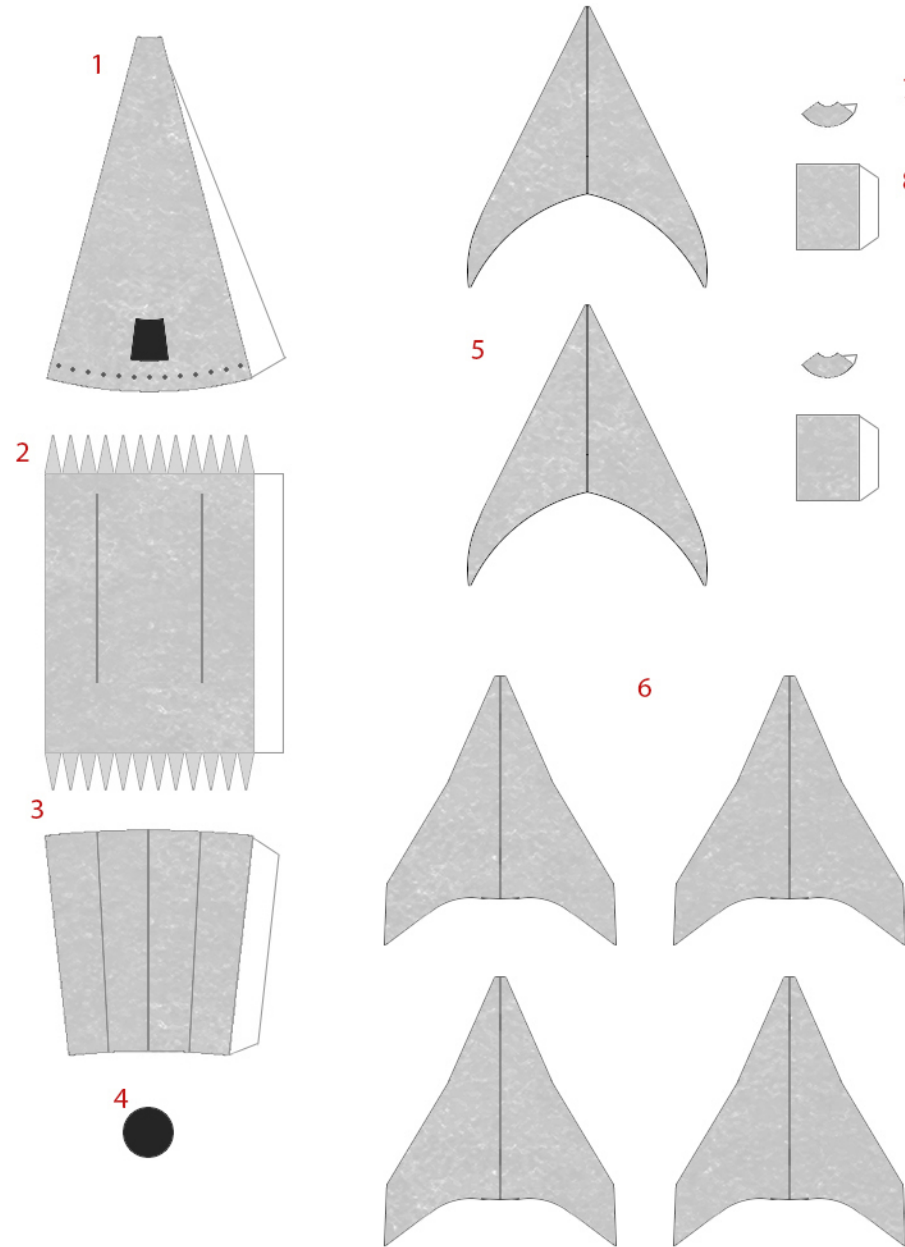

Fold-glue each of the six fins in half back-to-back

Instructions

Keep all seems aligned during assembly.
 Glue 4 to the bottom on the rocket.
 Glue 5 (2 fins) to the two lines on part 2.
 Glue 6 (4 fins) to the three lines and the seem on part 3.
 Glue 7 on top of 8 and glue on the bottom fins as shown.
 OR
 You can use pointed wooden skewers around 2.5 mm diameter. Shorten the points on the skewers, cut the skewers the same length as parts 7 and 8 glued together (around 14.5 mm long). Color them light grey or silver.

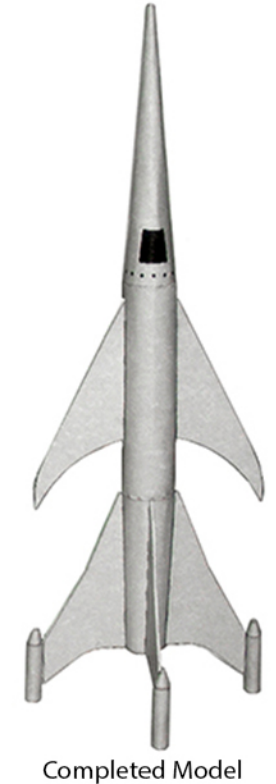
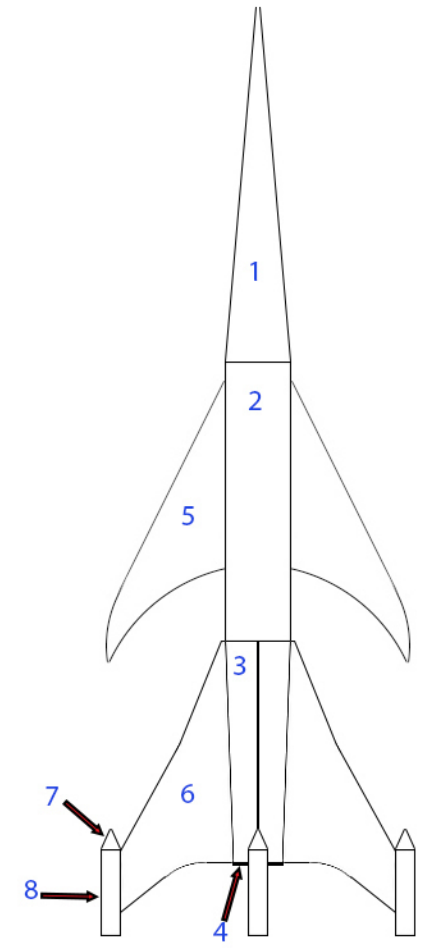

Retro Rocket ship 17

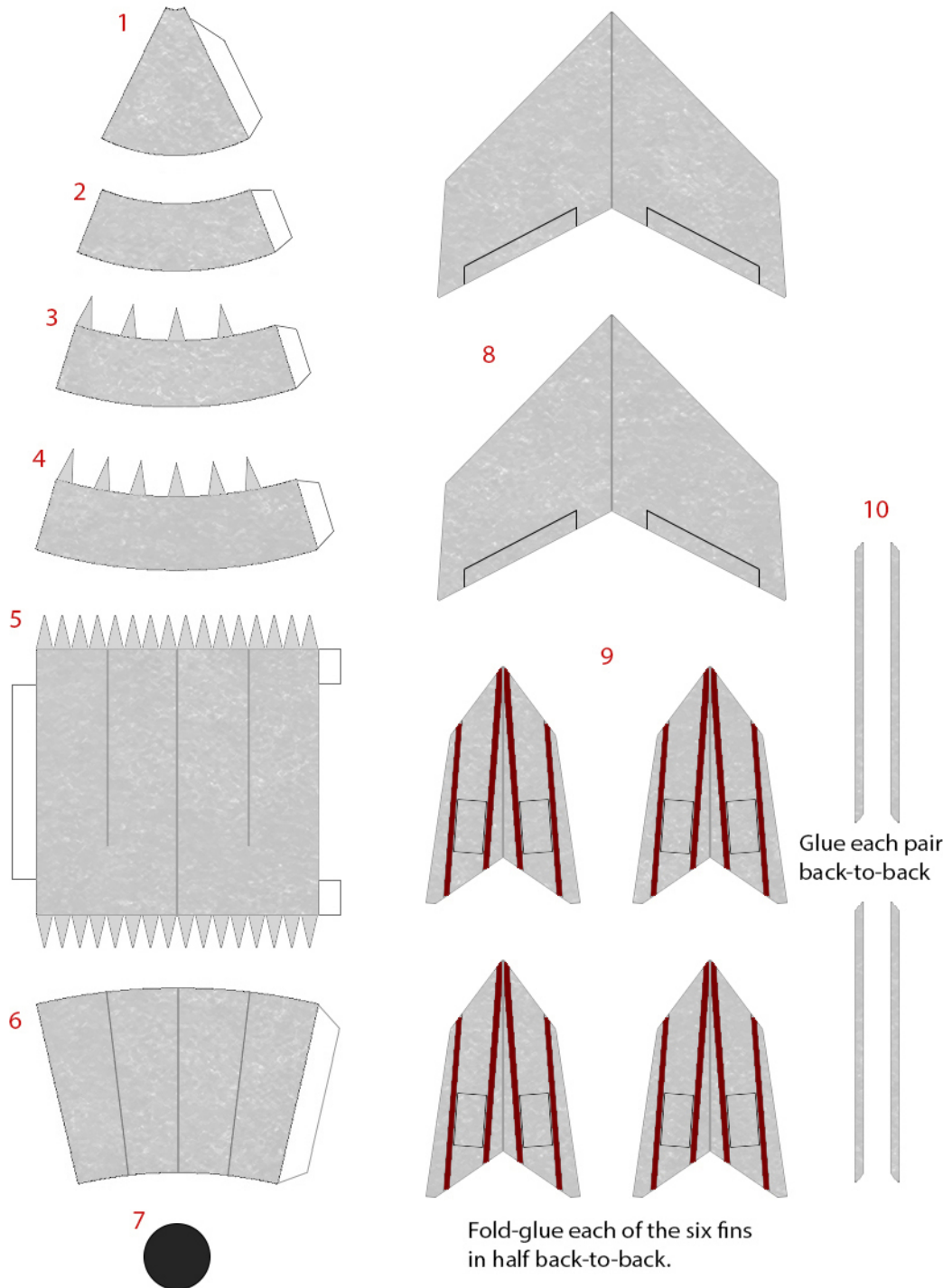

Instructions

Keep all seems aligned during assembly.
 Glue 7 to the bottom of the body.
 Glue 8 to the two short lines on 5
 Glue 9 to the three lines and seem on 6.
 Glue to 10 to the long line and seem on 5 as shown.

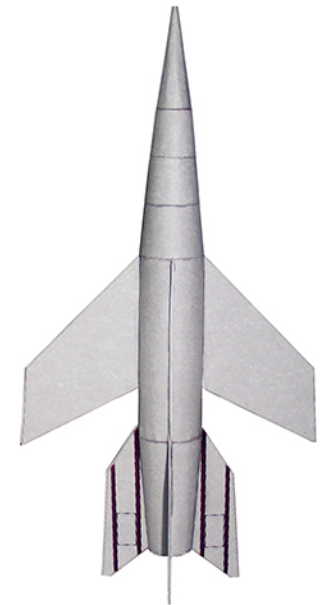
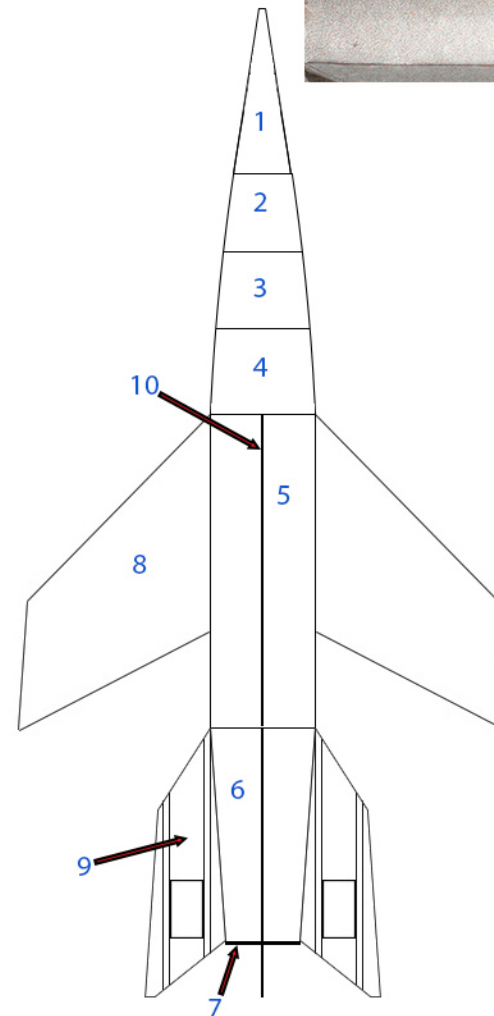
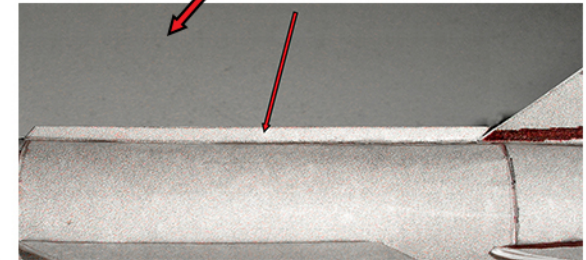

Completed Model

Retro Rocket ship 18

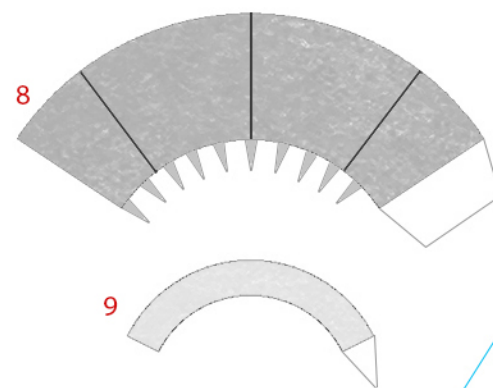
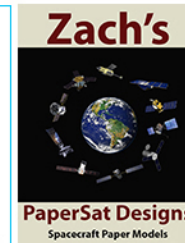
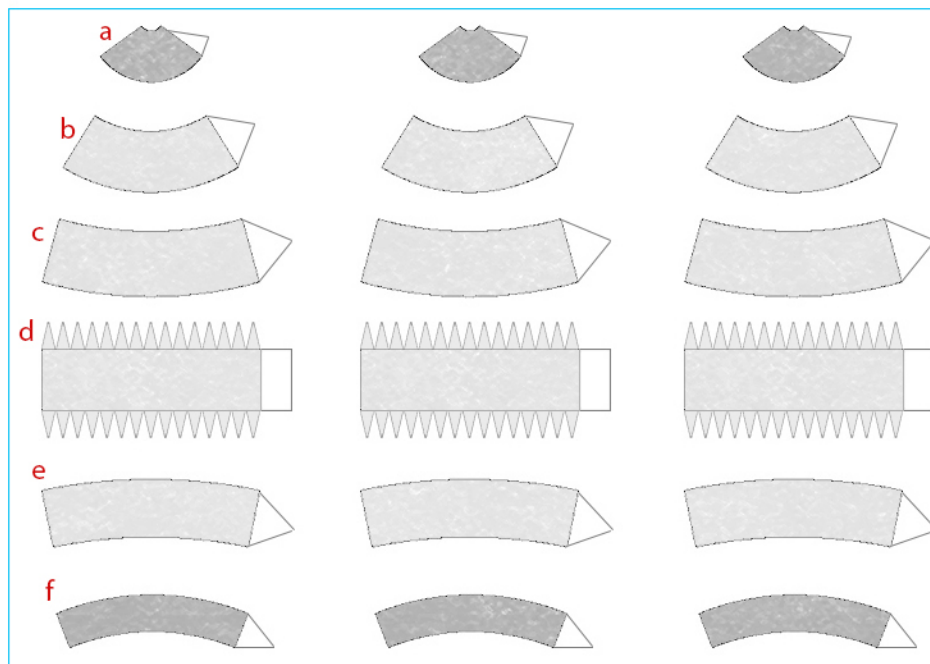
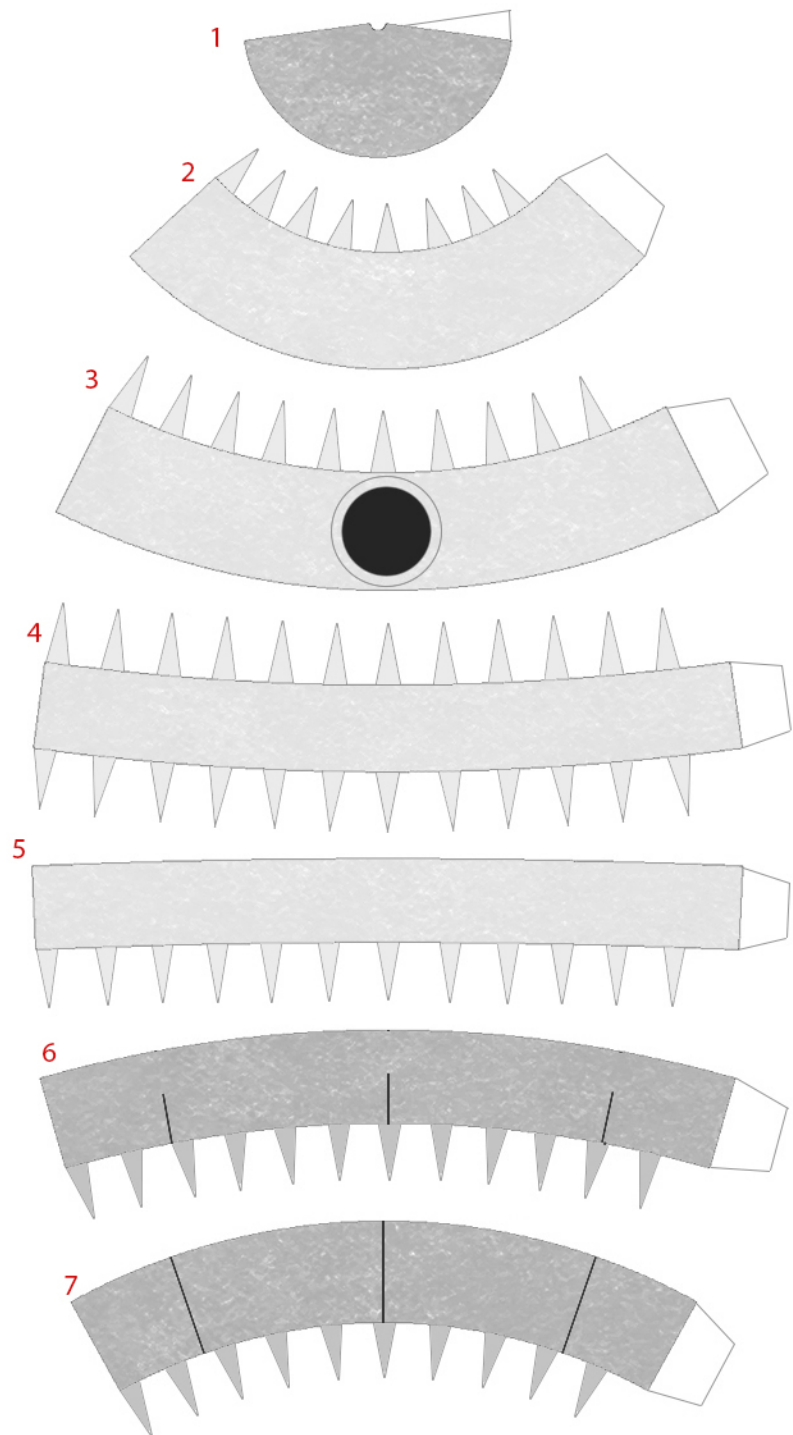

10
FINS - Glue each pair back-to-back

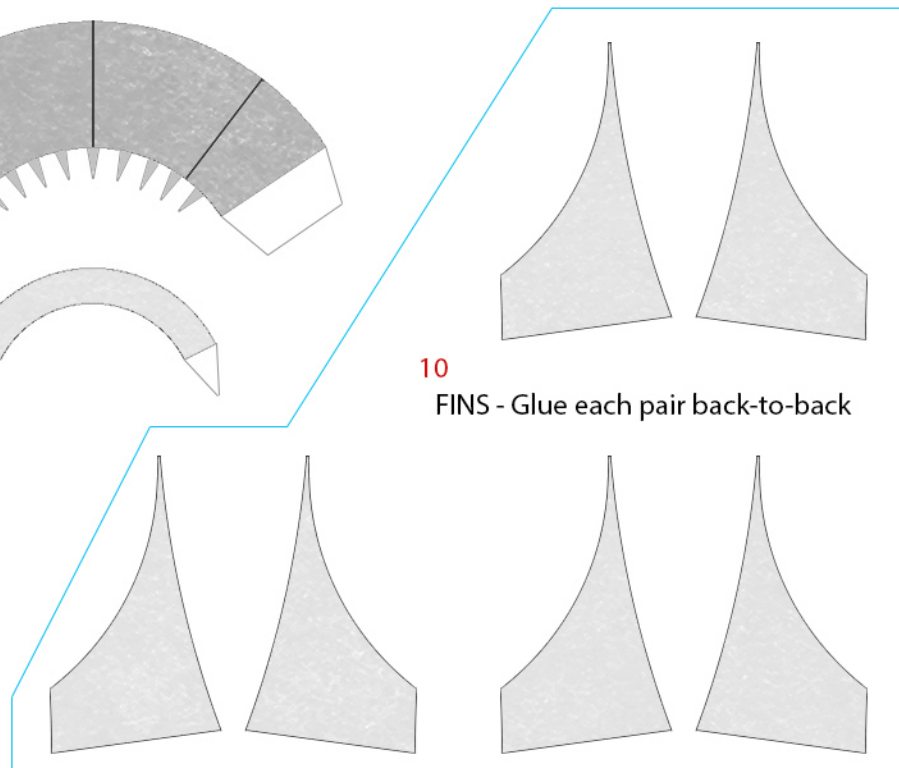

Retro Rocket ship 18

Instructions

- Keep all seams aligned during assembly.
- Glue the fins (parts 10) to the three lines on parts 6 - 8.
- Glue the three boosters on the end of the fins on part d as shown.

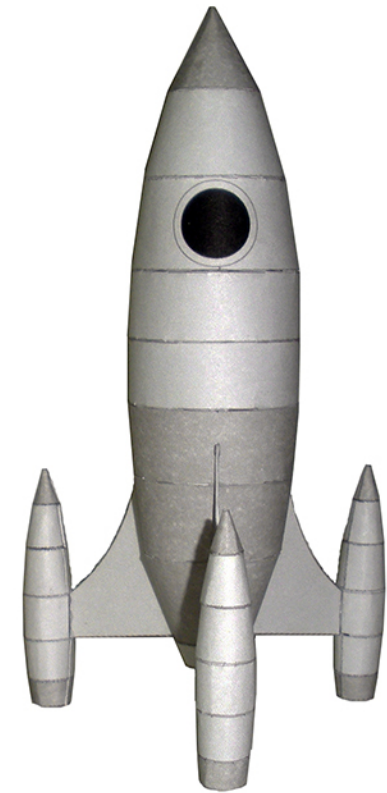
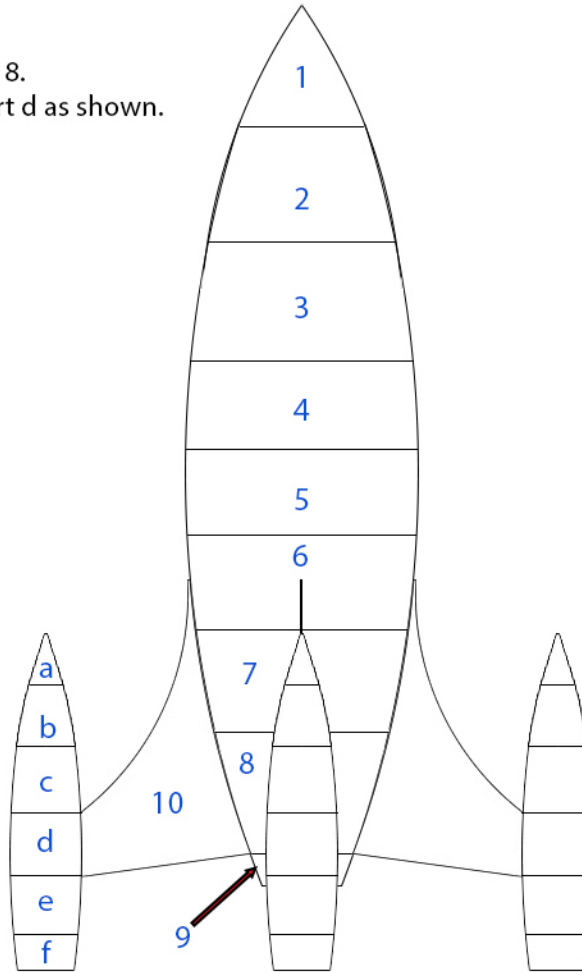

Completed Model



Retro Rocket ship 19

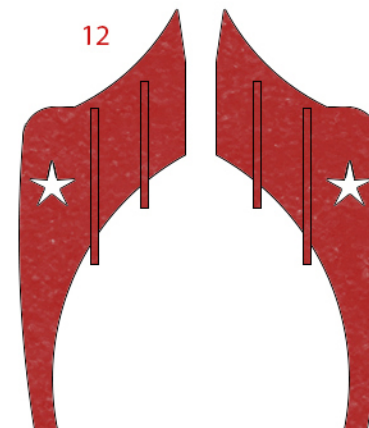
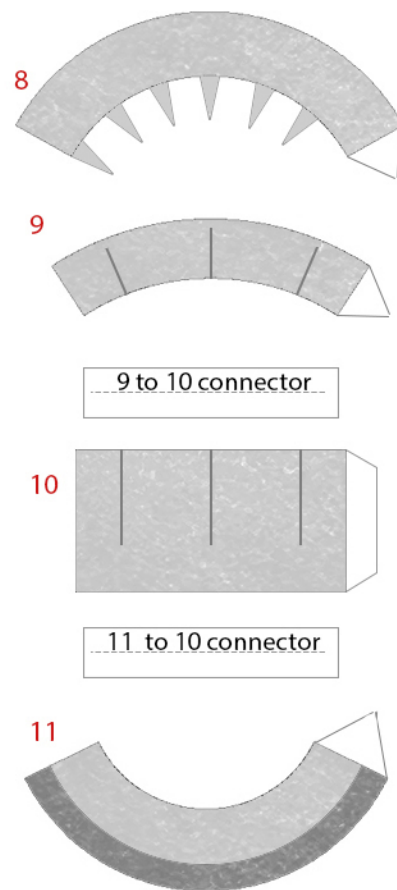
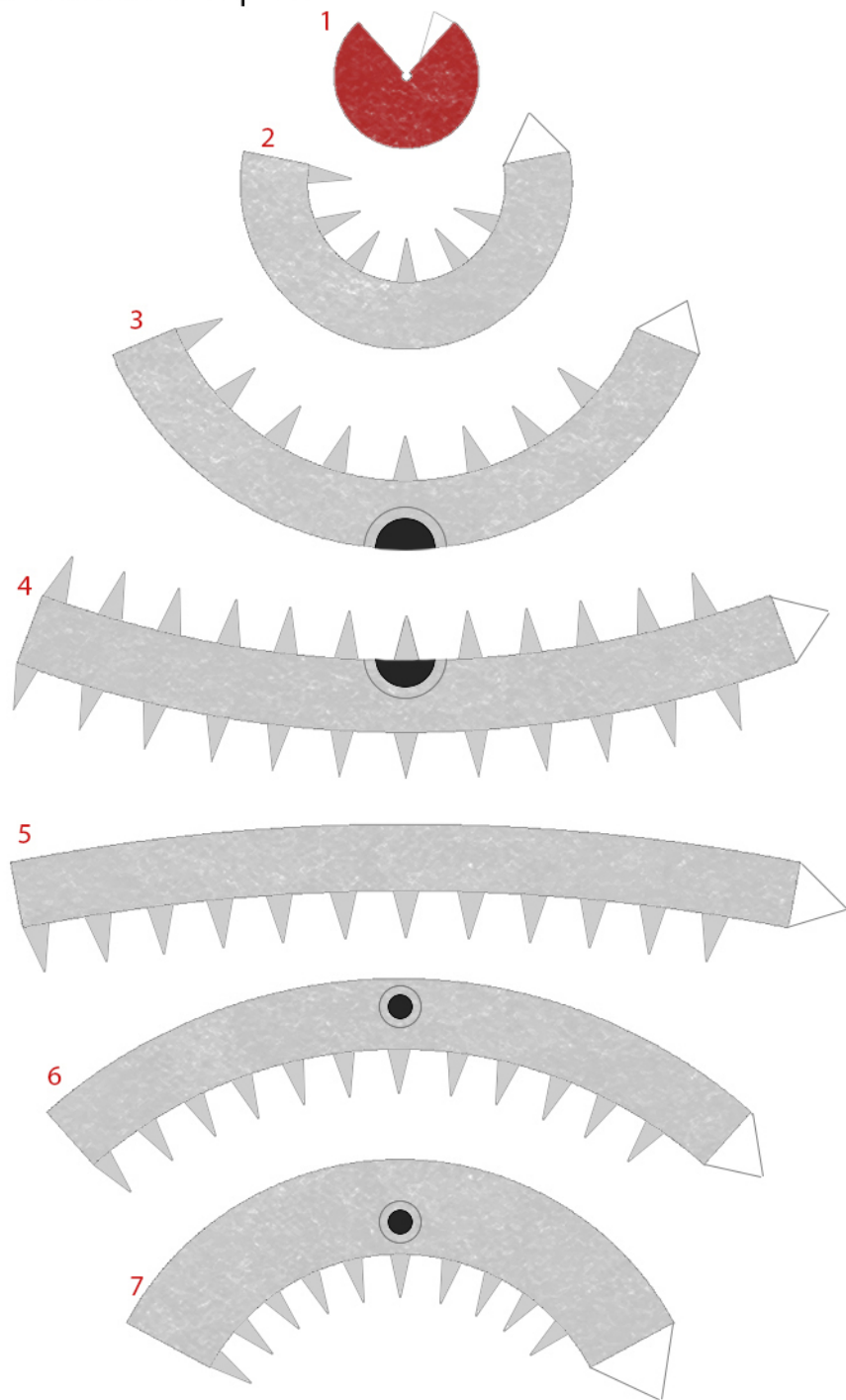

Glue each pair back-to-back

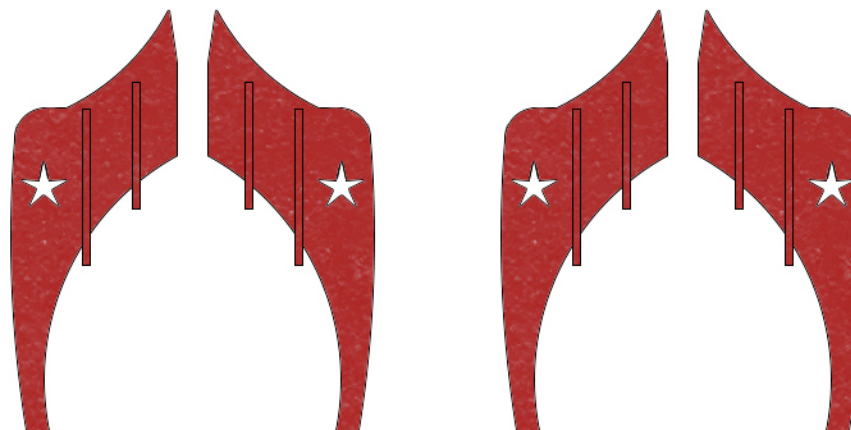

Retro Rocket ship 19

Instructions

Keep all seams aligned during assembly.
Glue the fins onto the three lines on part 10.

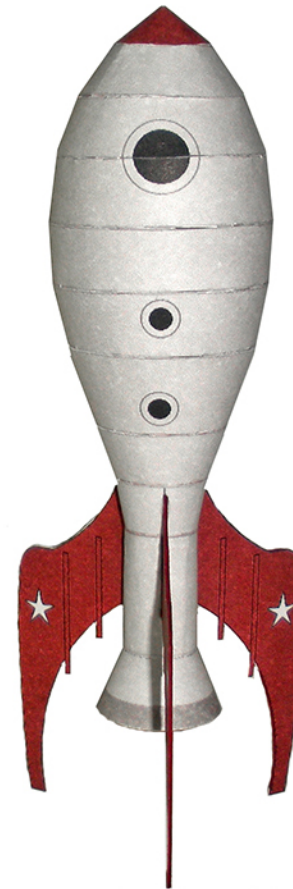
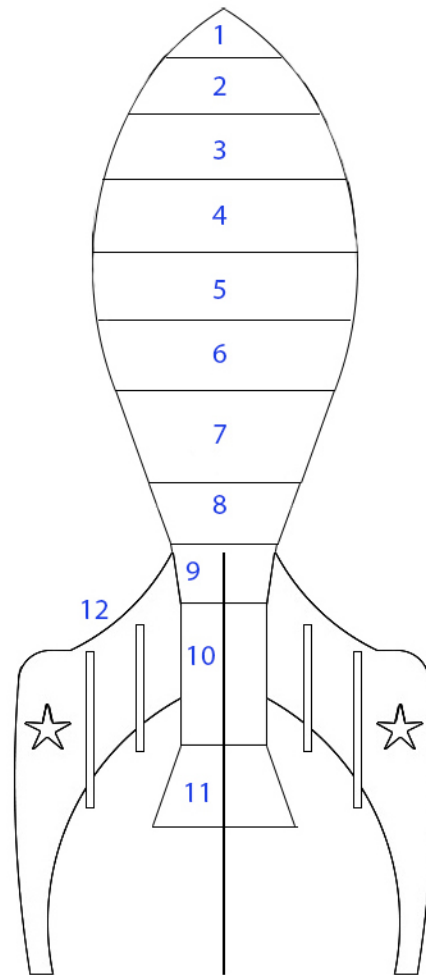

Completed model

Retro Rocket ship 20

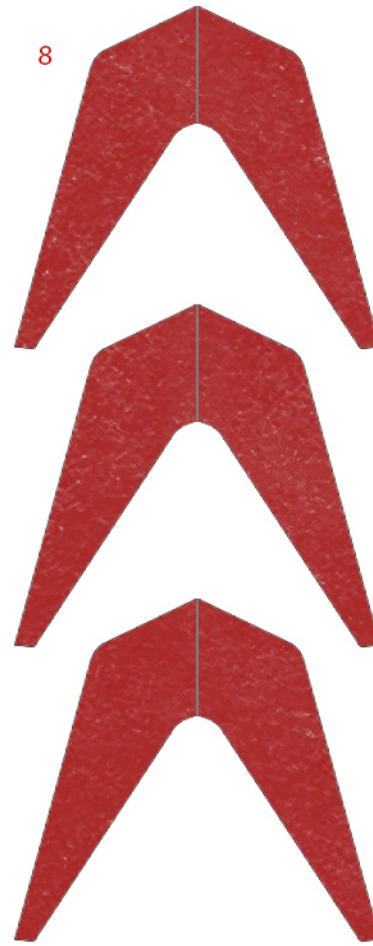
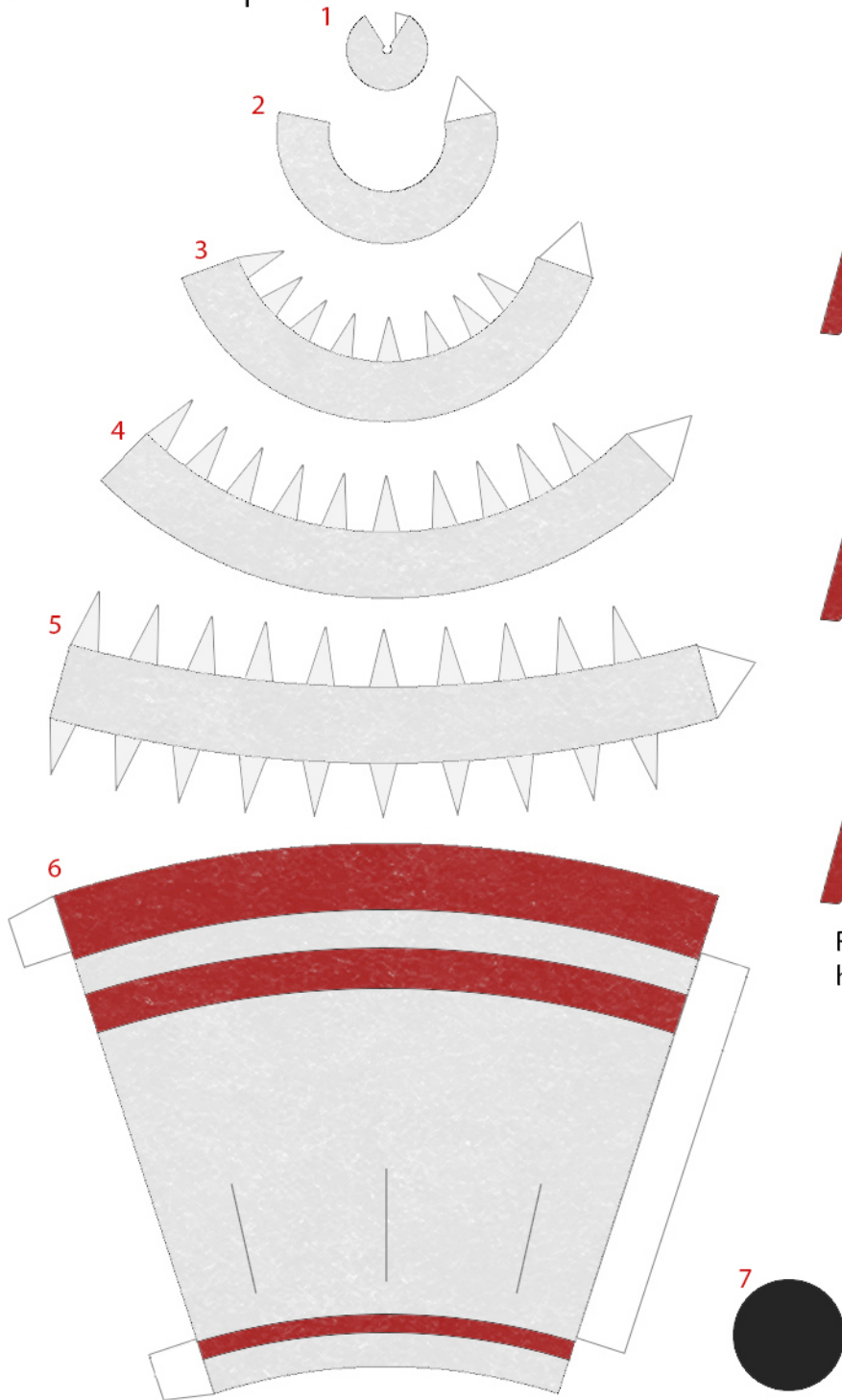

Fold-glue each set of fins in half back-to-back

Instructions

Keep all seems aligned during assembly.
Glue 7 to the bottom on the body.
Glue the fins on the three lines on part 6.

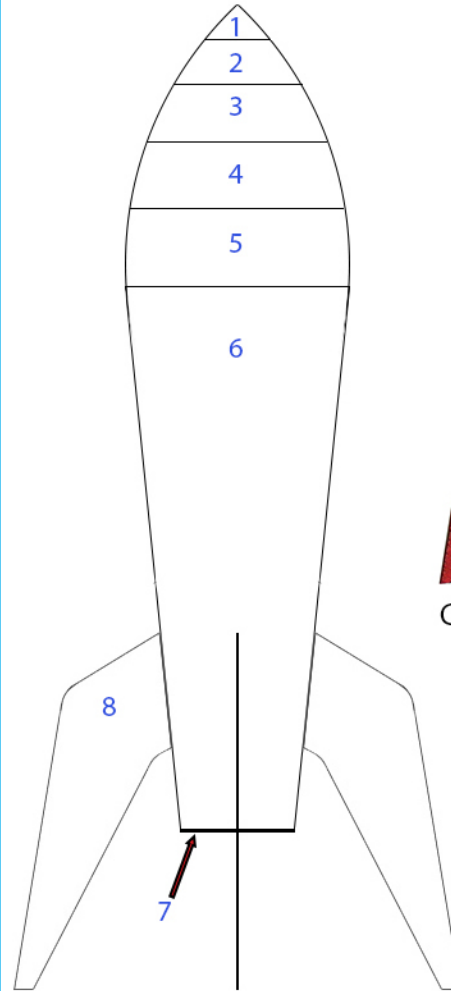

Completed model

Retro Rocket ship 21

1

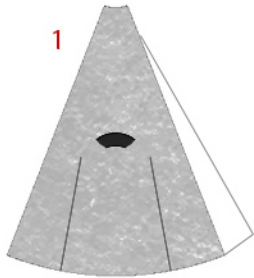

2

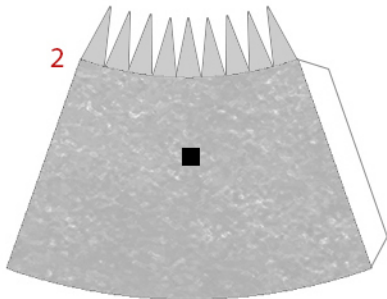

3

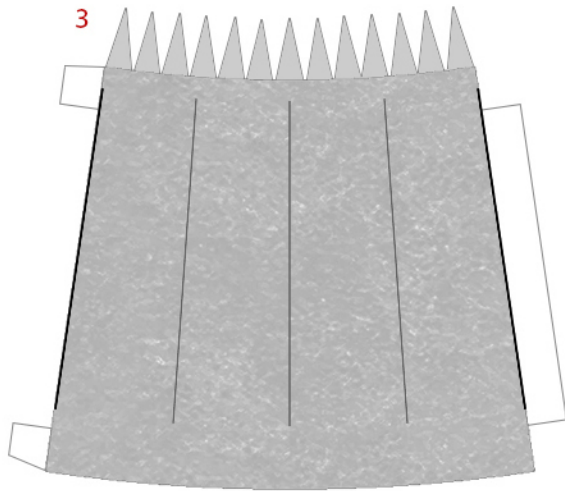

4



5

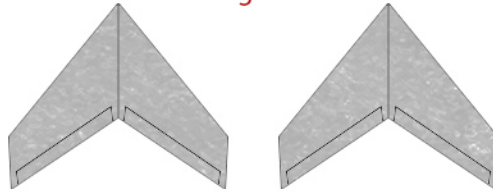

Fold-glue these six fins in half back-to-back

6

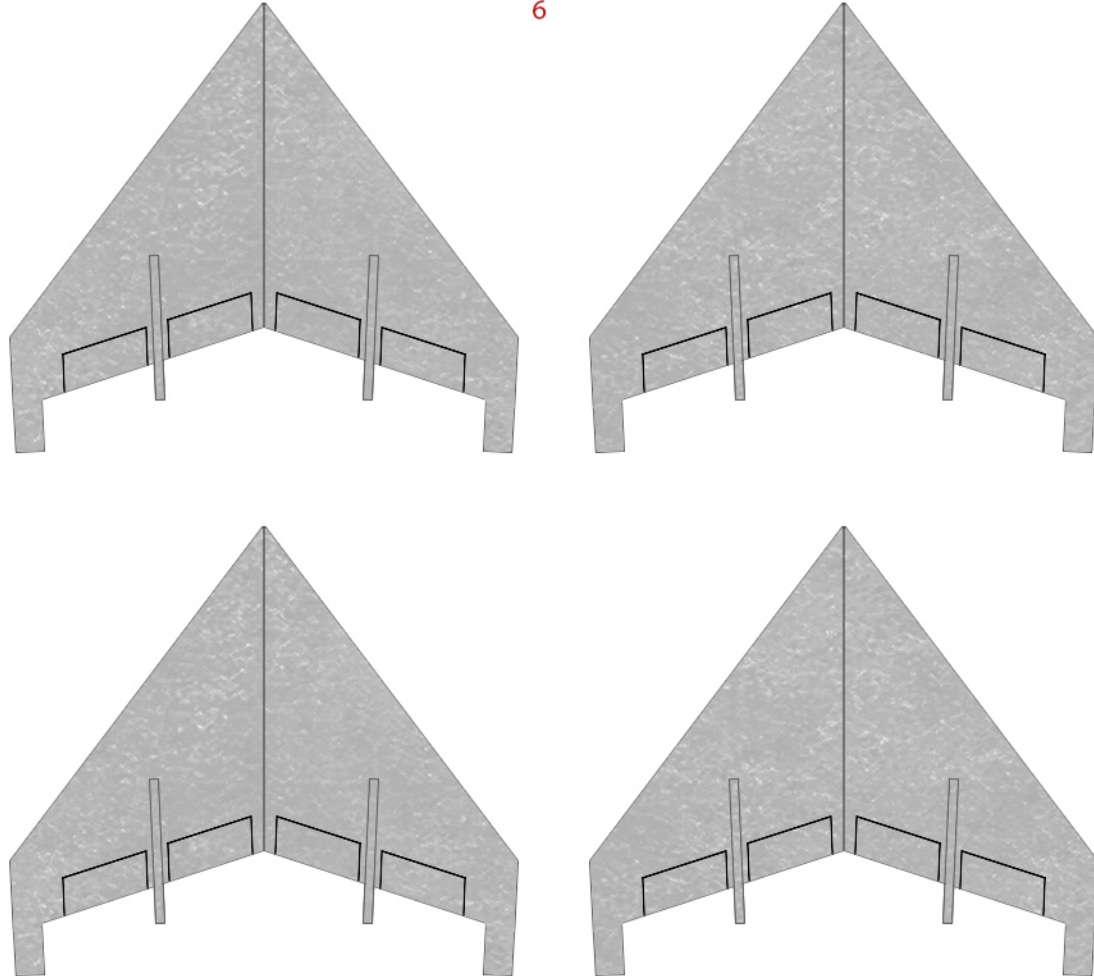

Instructions



Keep all seams aligned during assembly.

Glue 4 to the bottom on the rocket.

Glue 5 to the two lines on 1.

Glue 6 to the four dark lines (including the one on the seam) on part 3.

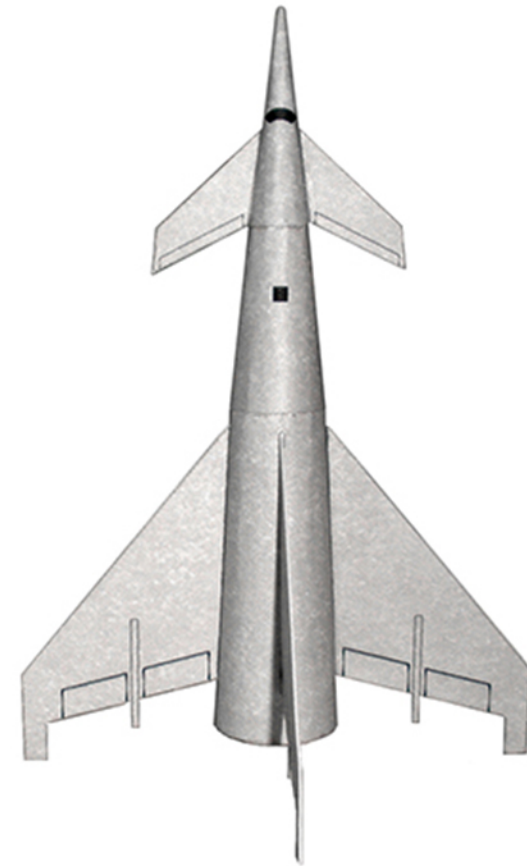
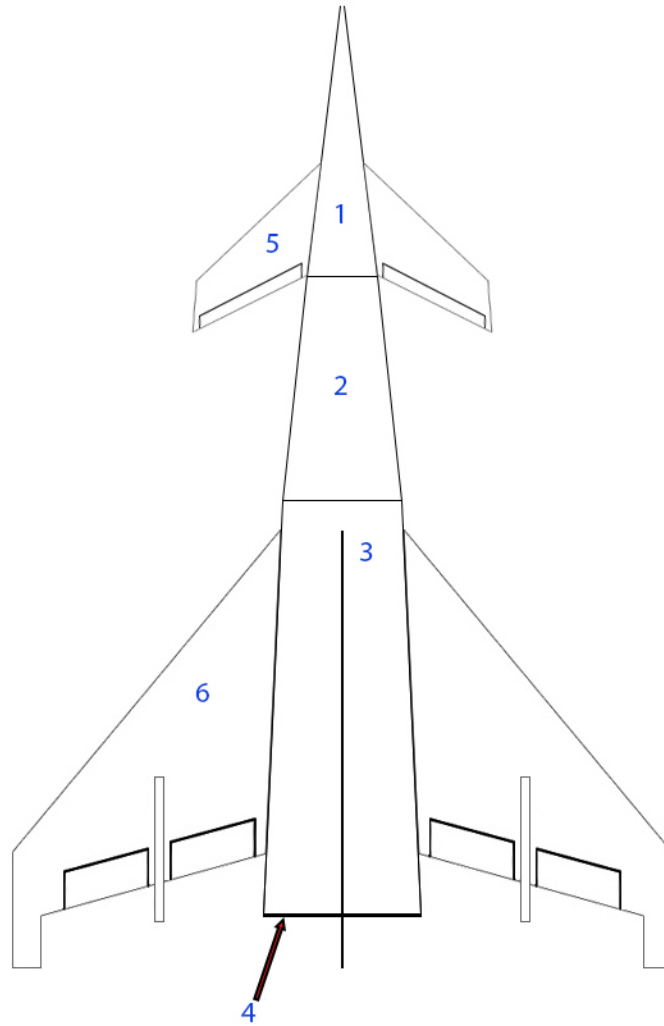

Completed Model

Retro Rocket ship 22

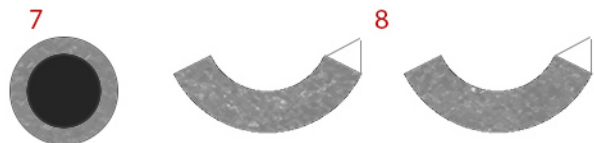
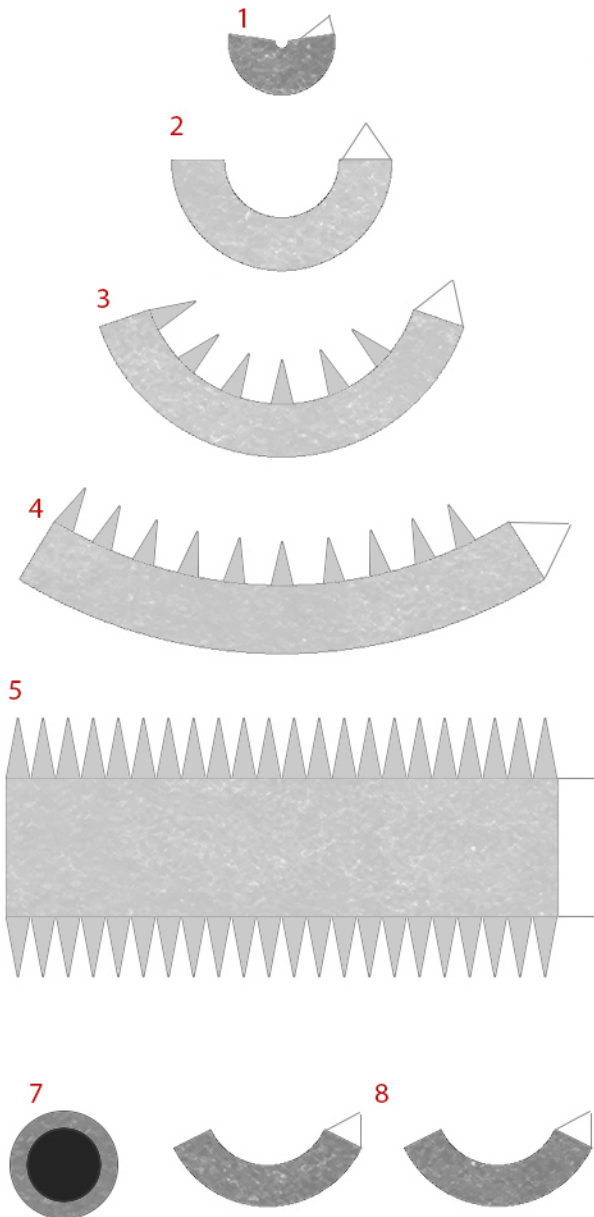

Parts 8 to 8 connector

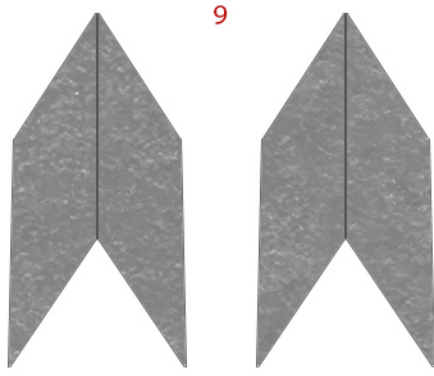
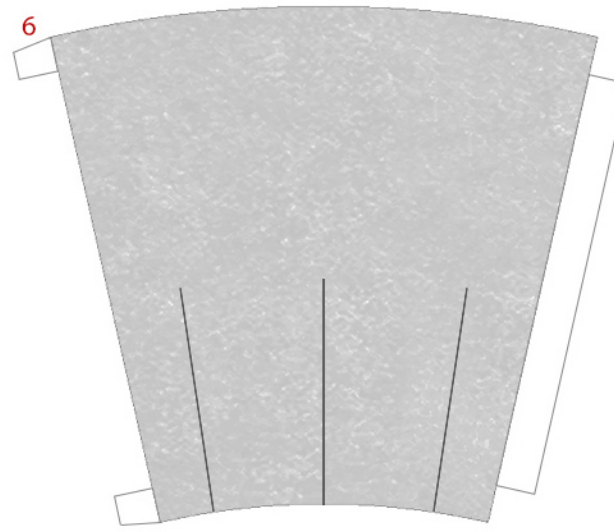

Fold-glue each fin in half back-to-back

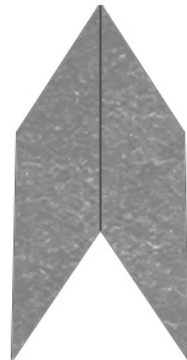

Instructions

Keep all seams aligned during assembly.
 Glue 7 to the bottom of the rocket.
 Glue parts 8 together with the small diameters together - see below.
 Glue this to the bottom of the rocket as shown.
 Glue the fins on the three lines on part 6.

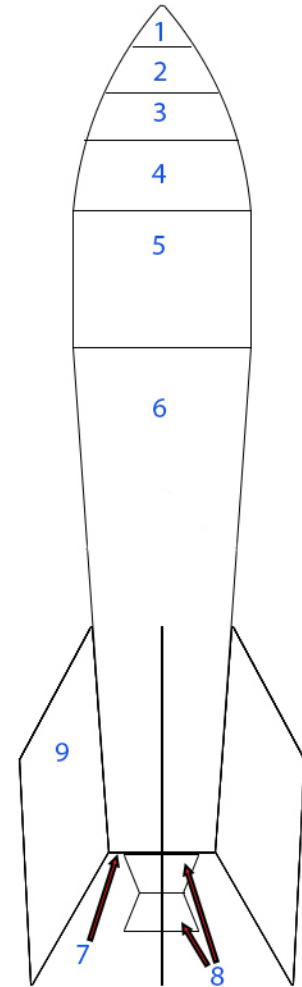

Completed Model

Close-up of nozzle assembly

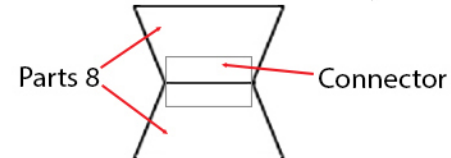

Retro Rocket ship 23

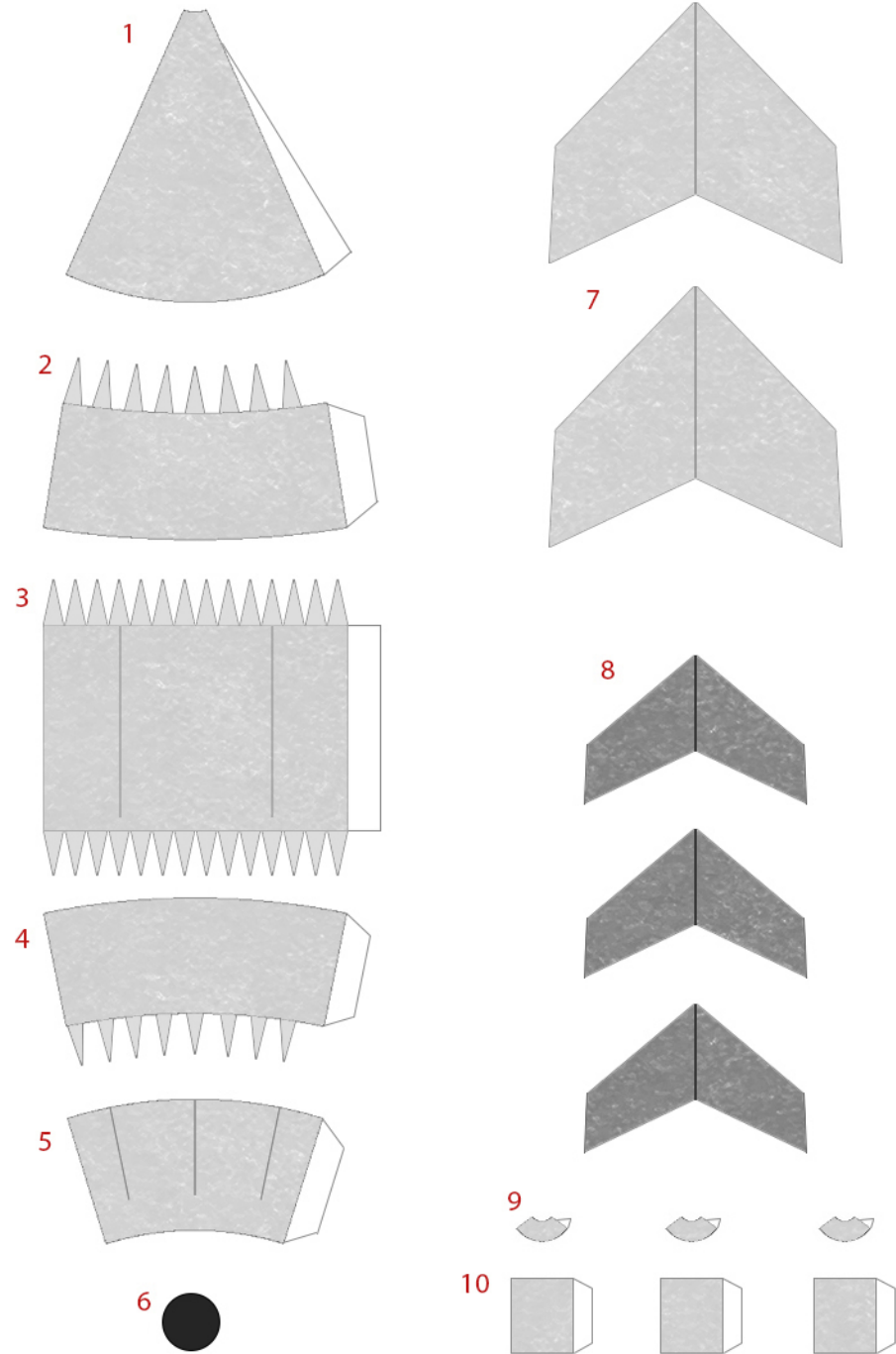

Instructions

Keep all seems aligned during assembly.
Glue 6 to the bottom of the rocket.
Glue 7 to the two lines on 3.
Glue 8 to the three lines on 5.
Glue 9 on top of 10.
Glue 9-10 to end of the fins (part 8) as shown below.

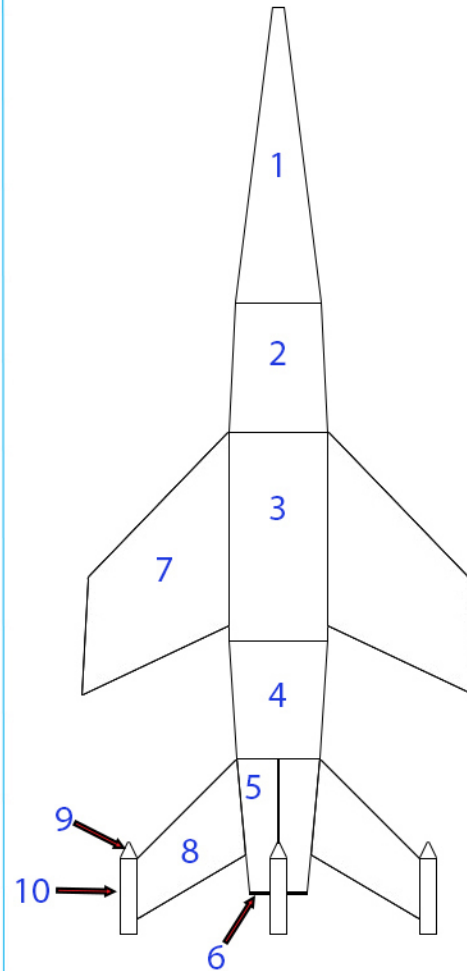

Completed Model

Retro Rocket ship 24

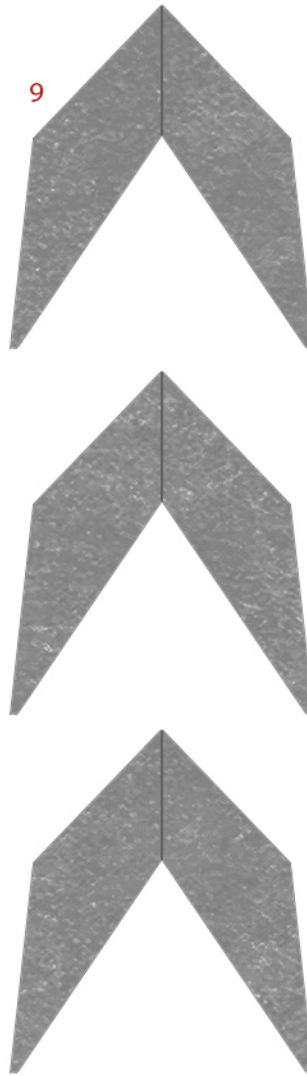
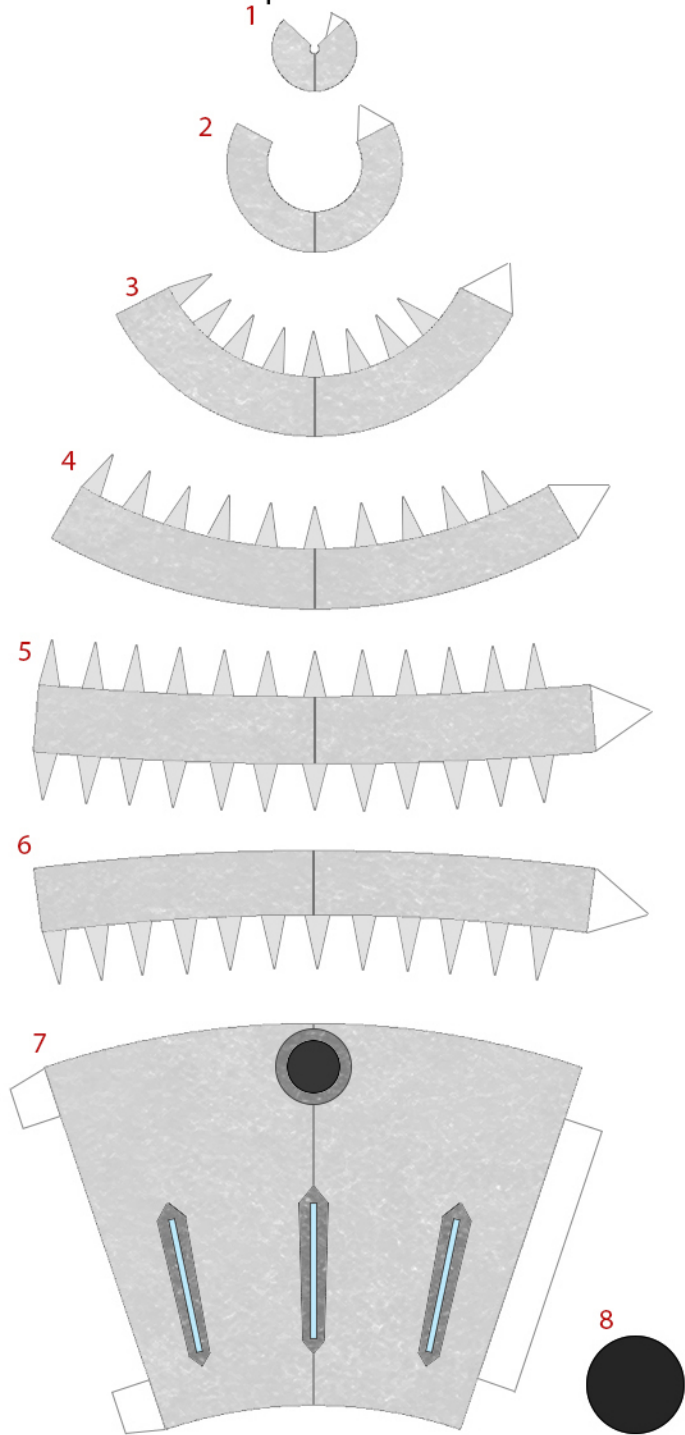

Instructions

Keep all seems aligned during assembly.
Glue 8 to the bottom of the rocket.
Glue the fins on the three blue lines on 7

Need a plastic broom straw or similar material cut at 12 mm long colored light grey or silver for the antenna.

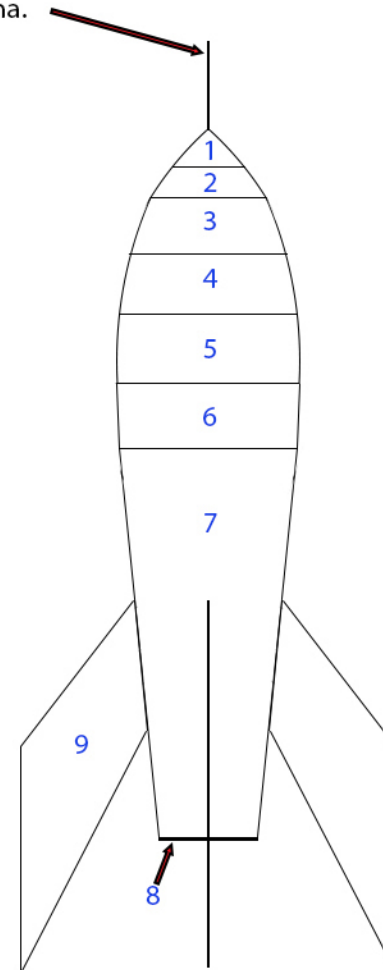

Completed Model

